

ARTESYN μMP SERIES GEN II

Up to 1800 Watts Configurable Power System



PRODUCT DESCRIPTION

Advanced Energy’s Artesyn μMP series GEN II power supply features a very wide 85 to 264 Vac input voltage range and employs active power factor correction to minimize input harmonic current distortion and to ensure compliance with the international EN61000-3-2 standard. The power supplies also feature active AC inrush control to automatically limit inrush current at turn-on to 40 A maximum. It can deliver up to 1800 Watts maximum from the μMP16 case. The power supply has a low profile 1U size and has a power density of more than 22.7 Watts per cubic inch. When fed with a 180 to 264 Vac input, the μMP series GEN II can achieve a very high - 91.5% typical efficiency at full case load.

SPECIAL FEATURES

- Full medical EN60601 approval
- PMBus monitor/control of input functions
- High efficiency
- Constant current limit protection
- High power density
 - μMP04: 10.8 W / in³
 - μMP09: 19.8 W / in³
 - μMP10: 15.1 W / in³
 - μMP16: 22.7 W / in³
- Low noise intelligent fan (speed control/fault status), 36% reduction from GEN I
- Downloadable GUI from website
- Optional conformal coating
- Industrial temp range (-40 °C to 70 °C)
- Military STD Shock (> 30 G) and Vibration (> 4 gRMS)
- No preload required
- Low cost
- IEC, terminal block or barrier strip input connection options
- Low profile 1U size
- Superior aesthetics over GEN I
- 2× MOPP Medical Application

SAFETY

- UL UL62368-1/CSA22.2 No.62368-1/ES60601-1/CSA22.2 No.62368-1
- TUV EN62368-1/EN60601-1
- CB Certificate and report
- CE LVD+RoHS
- CQC Approved
- UKCA Mark

AT A GLANCE

Total Power

Up to 1800 Watts

Input Voltage

85 to 264 Vac

of Outputs

Up to 12



MODEL NUMBERS

Ordering Information



①	Case Type	<p>Case Size where X = 04 = 1.57" x 3.5" x 10.0", 400W - 600W, 4 Slots 09 = 1.57" x 3.5" x 10.0", 550W - 1100W, 4 Slots 10 = 1.57" x 5.0" x 10.0", 1000W-1200W, 6 Slots 16 = 1.57" x 5.0" x 10.0", 1200W-1800W**, 6 Slots ** See Input Derating table for μMP16</p> <p>Input Type where Y = T = Terminal Block C = IEC Connector C14 S = Barrier Strip</p>
②	Module / Voltage	<p>Module Codes: S2 # = 200W Single O/P (1 slot) SK # = 1000W Single O/P (3 slot) I # # = 96W Dual O/P each output, Isolated GND (1 Slot) HUP = 224uF Bulk Capacitor (1 Slot) # = Voltage Codes: See voltage code table</p>
③	Case Option Codes	<p>First digit 0-9 = Parallel Code</p> <p>Second Digit 0 = Forward Air 1 = Reverse Air 2 = Not Used 3 = Global Enable 5 = Opt 1 + Opt 3</p>
④	Software Code	<p>Standard = A Modified Standards = factory assigned</p>
⑤	Hardware Code	<p>Standard = none Modified Standards = factory assigned</p>

MODEL NUMBERS

Case Size

Case	Max Output Power		Dimensions mm (inch)	Connections	Max Continuous Current
	85-179Vac ¹	180-264Vac			
μMP04 - 4 Slots	400W	600W	256.9 x 88.9 x 40.0 (10.11" x 3.5" x 1.57")	IEC Terminal-Block Barrier-Strip	9.91A
μMP09 - 4 Slots	550W	1100W	256.9 x 88.9 x 40.0 (10.11" x 3.5" x 1.57")	IEC Terminal-Block Barrier-Strip	9.91A
μMP10 - 6 Slots	1000W	1200W	256.9 x 127 x 40.0 (10.11" x 5.0" x 1.57")	IEC Terminal-Block Barrier-Strip	13.87A
μMP16 - 6 Slots	1000W	1800W	256.9 x 127 x 40.0 (10.11" x 5.0" x 1.57")	IEC Terminal-Block Barrier-Strip	13.87A

Note 1: The input voltage range for μMP09 is 90-264Vac.

μMP16 Input Power Derating

Parameter	85-99Vac	100-180Vac	180-199Vac	200-264Vac
Designed For	1000W	1200W	1600W	1800W
Safety Label and Evaluation	1000W	1000W	1600W	1600W

Case Input Type

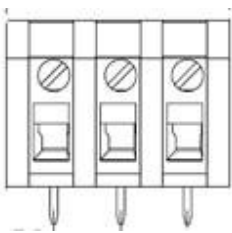

Terminal Block (T)



IEC Connector C14 (C)

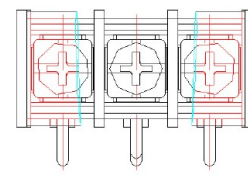

Barrier Strip (S)

MODEL NUMBERS

Voltage Codes

Standard Output Ratings													
Module Output Voltage Code		Signal Output				Dual Output							
		One Slot 240W Max		Three Slots 1000W Max		Module Group		One Slot 96W Max each output		Module Group			
Module Identification		S2 #		SK #		Output Voltage Range (V)		I # #		Output Voltage Range (V)			
Code (#)	Volts	Rated Output Current		Rated Output Current				V1 (A)	V2 (A)				
		V1 (A)	V1 (A)	V1 (A)	V2 (A)								
A	2.0	40.0	-	0.9 to 3.6	3V3 Module	NA		NA					
B	2.2	40.0	-			NA							
C	3.0	40.0	-			NA							
D	3.3	40.0	-			4.0	4.0						
E	5.0	36.0	-	3.2 to 6.0	5V Module	4.0	4.0	3.3 to 28.0		Dual ISO Module			
F	5.2	34.0	-			4.0	4.0						
G	5.5	32.0	-			4.0	4.0						
H	6.0	30.0	84.0			4.0	4.0						
I	8.0	25.0	84.0	6.0 to 15.0	12V Module	4.0	4.0				3.3 to 28.0		Dual ISO Module
J	10.0	24.0	84.0			4.0	4.0						
K	11.0	22.0	84.0			4.0	4.0						
L	12.0	20.0	84.0			4.0	4.0						
M	14.0	17.0	71.4	12.0 to 30.0	24V Module	4.0	4.0	3.3 to 28.0		Dual ISO Module			
N	15.0	16.0	66.7			4.0	4.0						
O	18.0	13.0	42.0			4.0	4.0						
P	20.0	12.0	42.0			4.0	4.0						
Q	24.0	10.0	42.0	33.0 to 60.0	48V Module	4.0	4.0				NA		Dual ISO Module
R	28.0	8.6	35.7			3.4	3.4						
S	30.0	8.0	33.3			3.2	3.2						
T	33.0	7	21.0			NA							
U	36.0	6.7	21.0	NA									
V	42.0	5.7	21.0	NA									
W	48.0	5.0	21.0	NA									
X	54.0	4.4	18.5	NA									
Y	60.0	4.0	16.7	NA									

* Note: For 1000W module, Output Voltages from 33.0-60.0V are available. Contact factory for availability of other output ranges.

MODEL NUMBERS

Parallel Codes (case option code - first digit)

Parallel Codes			
Code	Slots in Parallel	Code	Slots in Parallel
0	No module in parallel	9	1,2,3,4,5&6
1	1&2	A	1&2; 3&4
2	2&3	B	1,2&3; 4&5
3	3&4	C	1,2,3&4; 5&6
4	4&5	D	1&2; 3&4; 5&6
5	5&6	E	1,2&3; 4,5&6
6	1,2&3	H	3,4&5
7	1,2,3&4	J	3,4,5&6
8	1,2,3,4&5	K	4,5&6

Case Option Code - Second Digit

- 0=Forward Air
- 1=Reverse Air
- 2=Not Used
- 3=Global Enable
- 5=Opt 1+ Opt 3

μMP04 / μMP09

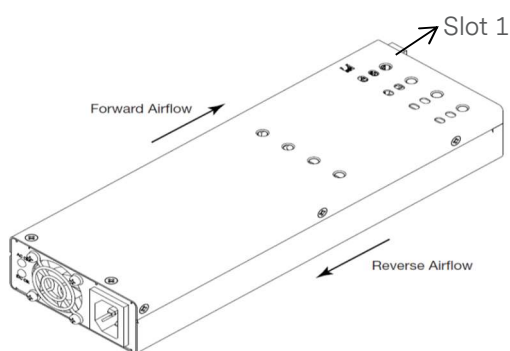

μMP10 / μMP16

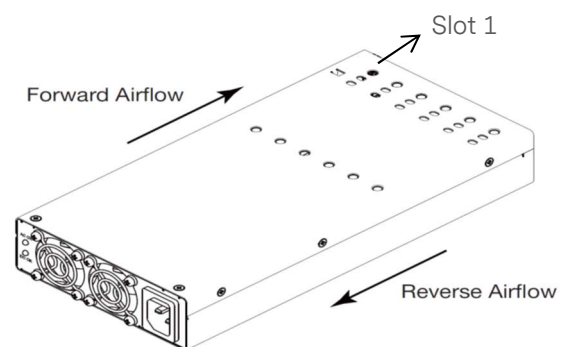

ELECTRICAL SPECIFICATIONS

Absolute Maximum Ratings

Stress in excess of those listed in the “Absolute Maximum Ratings” may cause permanent damage to the power supply. These are stress ratings only and functional operation of the unit is not implied at these or any other conditions above those given in the operational sections of this TRN. Exposure to any absolute maximum rated condition for extended periods may adversely affect the power supply’s reliability.

Table 1. Absolute Maximum Ratings							
Parameter	Models	Symbol	Min	Typ	Max	Unit	
Input Voltage	AC continuous operation (ITE)	All models	$V_{IN,AC}$	85	-	264	Vac
	AC continuous operation (Medical)	All models	$V_{IN,AC}$	85	-	264	Vac
	DC continuous operation (ITE)	μMP04, μMP09	$V_{IN,DC}$	120	-	350	Vdc
Maximum Output Power	μMP04	$P_{O,max}$	-	-	600	W	
	μMP09		-	-	1000	W	
	μMP10		-	-	1200	W	
	μMP16		-	-	1800	W	
Isolation Voltage (Qualification)	Input to outputs (2xMOPP)	All models	-	-	4000	Vac	
	Input to safety ground (1XMOPP)	All models	-	-	1500	Vac	
	Outputs to Outputs	All models	-	-	500	Vdc	
	Outputs to safety ground	All models	-	-	500	Vdc	
Isolation Voltage (Production)	Input to outputs	All models	-	-	1800	Vac	
	Input to safety ground	All models	-	-	1500	Vac	
	Outputs to Outputs	All models	-	-	500	Vdc	
	Outputs to safety ground	All models	-	-	500	Vdc	
Ambient Operating Temperature	Forward air	All models	T_A	-40 ¹	-	70 ¹	°C
	Reverse air	All models	T_A	-40	-	40	°C
Storage Temperature	All models	T_{STG}	-40	-	85	°C	
Humidity (non-condensing)	Operating	All models		20	-	90	%
	Non-operating	All models		10	-	95	%
Altitude	Operating	All models		-	-	10000 ²	feet
	Non-operating	All models		-	-	10000	feet

Note 1 - Derate each output 2.5% per degree from 50°C to 70°C. Cold start soak -20°C, allow 10 minutes warm-up before all outputs are with in specification. Reverse air to 40°C max due to fan derating.

Note 2 - Safety approved to 10000 feet operation altitude. Designed derate linear to 50% from 10000 - 30000 feet.

ELECTRICAL SPECIFICATIONS

Input Specifications

Table 2. Input Specifications						
Parameter	Condition	Symbol	Min	Typ	Max	Unit
Operating Input Voltage, AC	μMP04	$V_{IN,AC}$	85	115/230	264	Vac
	μMP09		90	115/230	264	Vac
	μMP10		85	115/230	264	Vac
	μMP16		85	115/230	264	Vac
Operating Input Voltage, DC ¹	μMP04 μMP09	$V_{IN,DC}$	120	-	350	Vdc
Input AC Frequency	All	$f_{IN,AC}$	47	50/60	440	Hz
Maximum Input Current ($I_O = I_{O,max}$, $I_{SB} = I_{SB,max}$)	μMP04	$I_{IN,max}$	-	-	9.91	A
	μMP09		-	-	9.91	A
	μMP10		-	-	13.87	A
	μMP16		-	-	13.87	A
Standby Input Current ($V_O = \text{Off}$, $I_{SB} = 0A$)	μMP04	$I_{IN,standby}$	-	-	200	mA
	μMP09		-	-	200	mA
	μMP10		-	-	500	mA
	μMP16		-	-	500	mA
Standby Input Power ($V_O = \text{Off}$, $I_{SB} = 0A$)	μMP04	$P_{IN,standby}$	-	-	6	W
	μMP09		-	-	6	W
	μMP10		-	-	13	W
	μMP16		-	-	13	W
No Load Input Current ($V_O = \text{On}$, $I_O = 0A$, $I_{SB} = 0A$)	μMP04	I_{IN,no_load}	-	-	350	mA
	μMP09		-	-	350	mA
	μMP10		-	-	500	mA
	μMP16		-	-	500	mA
Harmonic Line Currents	All	THD	Per EN61000-3-2			
Power Factor	$V_{IN,AC} = 115Vac$ $f_{IN,AC} = 47/63Hz$ $I_O = I_{O,max}$		-	0.99	-	
	$V_{IN,AC} = 115Vac$ $f_{IN,AC} = 380/440Hz$ $I_O = I_{O,max}$		-	0.80	-	

Note 1 – DC input for ITE only

ELECTRICAL SPECIFICATIONS

Input Specifications Con't

Table 2. Input Specifications Con't						
Parameter	Condition	Symbol	Min	Typ	Max	Unit
Inrush Current	$V_{IN,AC} = 264Vac$		-	-	40	A_{PK}
Input Fuse	μMP04		-	-	10	A
	μMP09		-	-	10	A
	μMP10		-	-	16	A
	μMP16		-	-	16	A
Leakage Current to Earth Ground	$V_{IN,AC} = 240Vac$ $f_{IN,AC} = 50/60Hz$		-	-	200 ¹	μA
	$V_{IN,AC} = 240Vac$ $f_{IN,AC} = 50/60Hz$		-	-	400	
PFC Switching Frequency	All	$f_{SW,PFC}$	60	-	80	KHz
Operating Efficiency ² @ 25°C	μMP04 ³	η	89.0	-	-	%
	μMP09 ⁴		90.0	-	-	%
	μMP10		91.0	-	-	%
	μMP16		90.5	-	-	%
Global Inhibit/Enable		TTL, Logic "1" and Logic "0"; fan off when unit is inhibited				

Note 1 - Using center-tapped xfrm measurement method.

Note 2 - These are taken at nominal 230Vac, 50H/60Hz AC input, room temp w/high efficiency modules.

For 12V SKL module, efficiency at 1000W using μMP16 at 230Vac case should be higher than 87%.

Note 3 - Test with two 12V modules.

Note 4 - Test with one 24V SKQ module.

ELECTRICAL SPECIFICATIONS

132W - 3V3 Module Output Specifications (S2A, S2B, S2C, S2D)

Table 3. 3.3V Module Output Specifications:						
Parameter	Condition	Symbol	Min	Typ	Max	Unit
Factory Set Point Accuracy	$I_o = \text{Half load}$	V_o	3.267	3.300	3.333	Vdc
Output Regulation ¹	Inclusive of line, load, temperature change and warm-up drift	$\pm\%V_o$	-	-	0.4	%
Margining High			3.432	-	3.498	Vdc
Margining Down			3.102	-	3.168	Vdc
Output Ripple, pk-pk	Measure with a 0.1μF ceramic capacitor in parallel with a 10μF tantalum capacitor, 0 to 20MHz bandwidth	V_o	-	-	50	mV _{PK-PK}
Output Current		I_o	-	-	40	A
V_o Current Share Accuracy	20% to 100% $I_{o,max}$		-	-	5	% $I_{o,max}$
V_o Minimum Current Share Loading			20	-	-	% $I_{o,max}$
Load Capacitance	Start up		-	-	2000	μF
V_o Dynamic Response ²	From 20% load 50% load change, slew rate = 1A/ms	$\pm\%V_o$ t_s	- -	- -	5 300	% μSec
V_o Long Term Stability Max change over 24 hours	After thermal equilibrium (30 mins)	$\pm\%V_o$	-	-	0.1	%

Note 1 - 0.4% or 30mV whichever is greater.

Note 2 - ±5% or 250mV (whichever is greater). Measured using external 100nF high frequency cap and E- cap listed in table below.

Vout (V)	Full load (A)	Peak Deviation trip (mV)	External E-Cap (μF)
0.9	40	250	1000
3.3	40	250	470
3.6	40	250	470

ELECTRICAL SPECIFICATIONS

180W - 5V Module Output Specifications (S2E, S2F, S2G, S2H)

Table 4. 5V Module Output Specifications:							
Parameter	Condition	Symbol	Min	Typ	Max	Unit	
Factory Set Point Accuracy	All	V_O	4.95	5.00	5.05	Vdc	
Output Regulation ¹	Inclusive of line, load, temperature change and warm-up drift	$\pm\%V_O$	-	-	0.4	%	
Margining High			5.2	-	5.3	Vdc	
Margining Down			4.7	-	4.8	Vdc	
Output Ripple, pk-pk	Measure with a 0.1μF ceramic capacitor in parallel with a 10μF tantalum capacitor, 0 to 20MHz bandwidth	V_O	-	-	50	mV _{PK-PK}	
Output Current		I_O	-	-	36	A	
V_O Current Share Accuracy	20% to 100% $I_{O,max}$		-	-	5	% $I_{O,max}$	
V_O Minimum Current Share Loading			20	-	-	% $I_{O,max}$	
Load Capacitance	Start up		-	-	2000	μF	
V_O Dynamic Response ²	Peak Deviation Settling Time	From 20% load 50% load change, slew rate = 1A/ms	$\pm\%V_O$	-	-	5	%
			t_s	-	-	300	μSec
V_O Long Term Stability Max change over 24 hours	After thermal equilibrium (30 mins)	$\pm\%V_O$	-	-	0.1	%	

Note 1 - 0.4% or 30mV whichever is greater.

Note 2 - ±5% or 250mV (whichever is greater). Measured using external 100nF high frequency cap and E- cap listed in table below.

Vout (V)	Full load (A)	Peak Deviation trip (mV)	External E-Cap (μF)
3.2	36.0	250	220
5.0	36.0	250	220
6.0	36.0	300	220

ELECTRICAL SPECIFICATIONS

240W - 12V Module Output Specifications (S2I, S2J, S2K, S2L, S2M, S2N)

Table 5. 12V Module Output Specifications:							
Parameter	Condition	Symbol	Min	Typ	Max	Unit	
Factory Set Point Accuracy	All	V_O	11.88	12.00	12.12	Vdc	
Output Regulation ¹	Inclusive of line, load, temperature change and warm-up drift	$\pm\%V_O$	-	-	0.4	%	
Margining High			12.48	-	12.72	Vdc	
Margining Down			11.28	-	11.52	Vdc	
Output Ripple, pk-pk	Measure with a 0.1μF ceramic capacitor in parallel with a 10μF tantalum capacitor, 0 to 20MHz bandwidth	V_O	-	-	120	mV _{PK-PK}	
Output Current		I_O	-	-	20	A	
V_O Current Share Accuracy	20% to 100% $I_{O,max}$		-	-	5	% $I_{O,max}$	
V_O Minimum Current Share Loading			20	-	-	% $I_{O,max}$	
Load Capacitance	Start up		-	-	2000	μF	
V_O Dynamic Response ²	Peak Deviation Settling Time	From 20% load. 50% load change, slew rate = 1A/ms	$\pm\%V_O$	-	-	5	%
			t_s	-	-	300	μSec
V_O Long Term Stability Max change over 24 hours	After thermal equilibrium (30 mins)	$\pm\%V_O$	-	-	0.1	%	

Note 1 - 0.4% or 30mV whichever is greater.

Note 2 - ±5% or 600mV (whichever is greater). Measured using external 100nF high frequency cap and E- cap listed in table below.

Vout (V)	Full load (A)	Peak Deviation trip (mV)	External E-Cap (μF)
6	25.0	300	1200
12	20.0	600	1200
15	16.0	750	1200

ELECTRICAL SPECIFICATIONS

240W - 24V Module Output Specifications (S2O, S2P, S2Q, S2R, S2S)

Table 6. 24V Module Output Specifications:							
Parameter	Condition	Symbol	Min	Typ	Max	Unit	
Factory Set Point Accuracy	All	V_O	23.76	24.00	24.24	V	
Output Regulation ¹	Inclusive of line, load, temperature change and warm-up drift	$\pm\%V_O$	-	-	0.4	%	
Margining High			24.96	-	25.44	V	
Margining Down			22.56	-	23.04	V	
Output Ripple, pk-pk	Measure with a 0.1μF ceramic capacitor in parallel with a 10μF tantalum capacitor, 0 to 20MHz bandwidth	V_O	-	-	240	mV _{PK-PK}	
Output Current		I_O	-	-	10	A	
V_O Current Share Accuracy	20% to 100% $I_{O,max}$		-	-	5	% $I_{O,max}$	
V_O Minimum Current Share Loading			20	-	-	% $I_{O,max}$	
Load Capacitance	Start up		-	-	2000	μF	
V_O Dynamic Response ²	Peak Deviation Settling Time	From 20% load. 50% load change, slew rate = 1A/ms	$\pm\%V_O$	-	-	5	%
			t_s	-	-	300	μSec
V_O Long Term Stability Max change over 24 hours	After thermal equilibrium (30 mins)	$\pm\%V_O$	-	-	0.1	%	

Note 1 - 0.4% or 30mV whichever is greater.

Note 2 - ±5% or 250mV (whichever is greater). Measured using external 100nF high frequency cap and E- cap listed in table below.

Vout (V)	Full load (A)	Peak Deviation trip (mV)	External E-Cap (μF)
12	17.0	600	220
24	10.0	1200	220
48	8.0	1500	220

ELECTRICAL SPECIFICATIONS

240W - 48V Module Output Specifications (S2T, S2U, S2V, S2W, S2X, S2Y)

Table 7. 48V Module Output Specifications:							
Parameter	Condition	Symbol	Min	Typ	Max	Unit	
Factory Set Point Accuracy	All	V_O	47.52	48.00	48.48	Vdc	
Output Regulation ¹	Inclusive of line, load, temperature change and warm-up drift	$\pm\%V_O$	-	-	0.4	%	
Margining High			49.92	-	50.88	Vdc	
Margining Down			45.12	-	46.08	Vdc	
Output Ripple, pk-pk	Measure with a 0.1μF ceramic capacitor in parallel with a 10μF tantalum capacitor, 0 to 20MHz bandwidth	V_O	-	-	480	mV _{PK-PK}	
Output Current		I_O	-	-	5	A	
V_O Current Share Accuracy	20% to 100% $I_{O,max}$		-	-	5	% $I_{O,max}$	
V_O Minimum Current Share Loading			20	-	-	% $I_{O,max}$	
Load Capacitance	Start up		-	-	2000	μF	
V_O Dynamic Response ²	Peak Deviation Settling Time	From 20% load. 50% load change, slew rate = 1A/ms	$\pm\%V_O$	-	-	5	%
			t_s	-	-	300	μSec
V_O Long Term Stability Max change over 24 hours	After thermal equilibrium (30 mins)	$\pm\%V_O$	-	-	0.1	%	

Note 1 - 0.4% or 30mV whichever is greater.

Note 2 - ±5% or 250mV (whichever is greater). Measured using external 100nF high frequency cap and E- cap listed in table below.

Vout (V)	Full load (A)	Peak Deviation trip (mV)	External E-Cap (μF)
28	7.0	1400	220
48	5.0	2400	220
60	4.0	3000	220

ELECTRICAL SPECIFICATIONS

1000W - 12V Module Output Specifications (SKH,SKI, SKJ, SKK, SKL, SKM, SKN)

Table 8. 12V Module Output Specifications:							
Parameter	Condition	Symbol	Min	Typ	Max	Unit	
Factory Set Point Accuracy	All	V_O	11.88	12.00	12.12	Vdc	
Output Regulation ¹	Inclusive of line, load, temperature change and warm-up drift	$\pm\%V_O$	-	-	0.4	%	
Margining High			12.48	-	12.72	Vdc	
Margining Down			11.28	-	11.52	Vdc	
Output Ripple, pk-pk	Measure with a 0.1μF ceramic capacitor in parallel with a 10μF tantalum capacitor, 0 to 20MHz bandwidth	V_O	-	-	120	mV _{PK-PK}	
Output Current		I_O	-	-	84	A	
V_O Current Share Accuracy	20% to 100% $I_{O,max}$		-	-	5	% $I_{O,max}$	
V_O Minimum Current Share Loading			20	-	-	% $I_{O,max}$	
Load Capacitance	Start up		-	-	2000	μF	
V_O Dynamic Response ²	Peak Deviation Settling Time	From 20% load 50% load change, slew rate = 1A/ms	$\pm\%V_O$	-	-	5	%
			t_s	-	-	300	μSec
V_O Long Term Stability Max change over 24 hours	After thermal equilibrium (30 mins)	$\pm\%V_O$	-	-	0.1	%	

Note 1 - 0.4% or 30mV whichever is greater.

Note 2 - ±5% or 600mV (whichever is greater). Measured using external 100nF high frequency cap and E- cap listed in table below.

Vout (V)	Full load (A)	Peak Deviation trip (mV)	External E-Cap (μF)
6	25.0	300	1200
12	20.0	600	1200
15	16.0	750	1200

ELECTRICAL SPECIFICATIONS

1000W - 24V Module Output Specifications (SKO, SKP, SKQ, SKR, SKS)

Table 9. 24V Module Output Specifications:							
Parameter	Condition	Symbol	Min	Typ	Max	Unit	
Factory Set Point Accuracy	All	V_O	23.76	24.00	24.24	Vdc	
Output Regulation ¹	Inclusive of line, load, temperature change and warm-up drift	$\pm\%V_O$	-	-	0.4	%	
Margining High			24.96	-	25.44	Vdc	
Margining Down			22.56	-	23.04	Vdc	
Output Ripple, pk-pk	Measure with a 0.1μF ceramic capacitor in parallel with a 10μF tantalum capacitor, 0 to 20MHz bandwidth	V_O	-	-	240	mV _{PK-PK}	
Output Current		I_O	-	-	42	A	
V_O Current Share Accuracy	20% to 100% $I_{O,max}$		-	-	5	% $I_{O,max}$	
V_O Minimum Current Share Loading			20	-	-	% $I_{O,max}$	
Load Capacitance	Start up		-	-	2000	μF	
V_O Dynamic Response ²	Peak Deviation Settling Time	From 20% load 50% load change, slew rate = 1A/ms	$\pm\%V_O$	-	-	5	%
			t_s	-	-	300	μSec
V_O Long Term Stability Max change over 24 hours	After thermal equilibrium (30 mins)	$\pm\%V_O$			0.1	%	

Note 1 - 0.4% or 30mV whichever is greater.

Note 2 - ±5% or 250mV (whichever is greater). Measured using external 100nF high frequency cap and E- cap listed in table below.

Vout (V)	Full load (A)	Peak Deviation trip (mV)	External E-Cap (μF)
12	17.0	600	220
24	10.0	1200	220
30	8.0	1500	220

ELECTRICAL SPECIFICATIONS

1000W - 48V Module Output Specifications (SKT, SKU, SKV, SKW, SKX, SKY)

Table 10. 48V Module Output Specifications:							
Parameter	Condition	Symbol	Min	Typ	Max	Unit	
Factory Set Point Accuracy	All	V_O	47.52	48.00	48.48	Vdc	
Output Regulation ¹	Inclusive of line, load, temperature change and warm-up drift	$\pm\%V_O$	-	-	0.4	%	
Margining High			49.92	-	50.88	Vdc	
Margining Down			45.12	-	46.08	Vdc	
Output Ripple, pk-pk	Measure with a 0.1μF ceramic capacitor in parallel with a 10μF tantalum capacitor, 0 to 20MHz bandwidth	V_O	-	-	480	mV _{PK-PK}	
Output Current		I_O	-	-	21	A	
V_O Current Share Accuracy	20% to 100% $I_{O,max}$		-	-	5	% $I_{O,max}$	
V_O Minimum Current Share Loading			20	-	-	% $I_{O,max}$	
Load Capacitance	Start up		-	-	2000	μF	
V_O Dynamic Response ²	Peak Deviation Settling Time	From 20% load 50% load change, slew rate = 1A/ms	$\pm\%V_O$	-	-	5	%
			t_s	-	-	300	μSec
V_O Long Term Stability Max change over 24 hours	After thermal equilibrium (30 mins)	$\pm\%V_O$	-	-	0.1	%	

Note 1 - 0.4% or 30mV whichever is greater.

Note 2 - ±5% or 250mV (whichever is greater). Measured using external 100nF high frequency cap and E- cap listed in table below.

Vout (V)	Full load (A)	Peak Deviation trip (mV)	External E-Cap (μF)
28	7.0	1400	220
48	5.0	2400	220
60	4.0	3000	220

ELECTRICAL SPECIFICATIONS

96W/96W - Dual ISO Module Output Specifications (I##)¹

Table 11. 3.3-28V Module Output Specifications:						
Parameter	Condition	Symbol	Min	Typ	Max	Unit
Factory Set Point Accuracy	All	V_O	-	-	1	%
Output Regulation ²	Inclusive of line, load, temperature change and warm-up drift	$\pm\%V_O$	-	-	0.4	%
Output Ripple, pk-pk	Measure with a 0.1μF ceramic capacitor in parallel with a 10μF tantalum capacitor, 0 to 20MHz bandwidth	V_O	-	-	1	%
Output Current		I_O	-	-	4	A
Load Capacitance	Start up		-	-	2000	μF
V_O Dynamic Response ³	From 20% load					
Peak Deviation	50% load change, slew rate = 1A/ms	$\pm\%V_O$	-	-	5	%
Settling Time		t_s	-	-	300	μSec
V_O Long Term Stability Max change over 24 hours	After thermal equilibrium (30 mins)	$\pm\%V_O$	-	-	0.1	%

Note 1 - ## see voltage codes in page 4.

Note 2 - 0.4% or 30mV which ever is greater.

Note 3 - ±5% or 250mV (whichever is greater). For 73-963-0012-G2, transient requirement is < 5% or 600mV (whichever is greater). Measured using external 100nF high frequency cap and E- cap. Refer to single module table.

ELECTRICAL SPECIFICATIONS

HUP Module Specifications (HUP)

The μMP HUP module is intended for use on μMP series with high efficiency module configurations. Its application is limited with μMP configurations and may have multiple HUP's inserted.

The HUP module can provide additional 224uF bulk capacitance (typ.). The following is an example of μMP09 configuration. Typical hold-up time increased with HUP module in μMP09 case and SK* module is 10ms at 500W load.

Typical HUP Response with μMP09-S2* Configuration

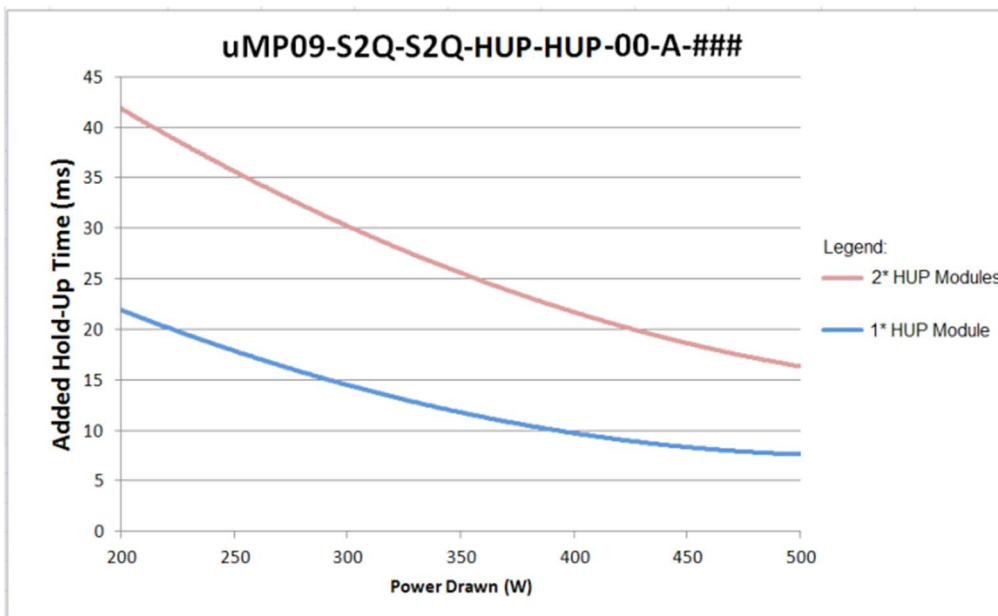

Typical HUP Response with μMP09-SKW Configuration

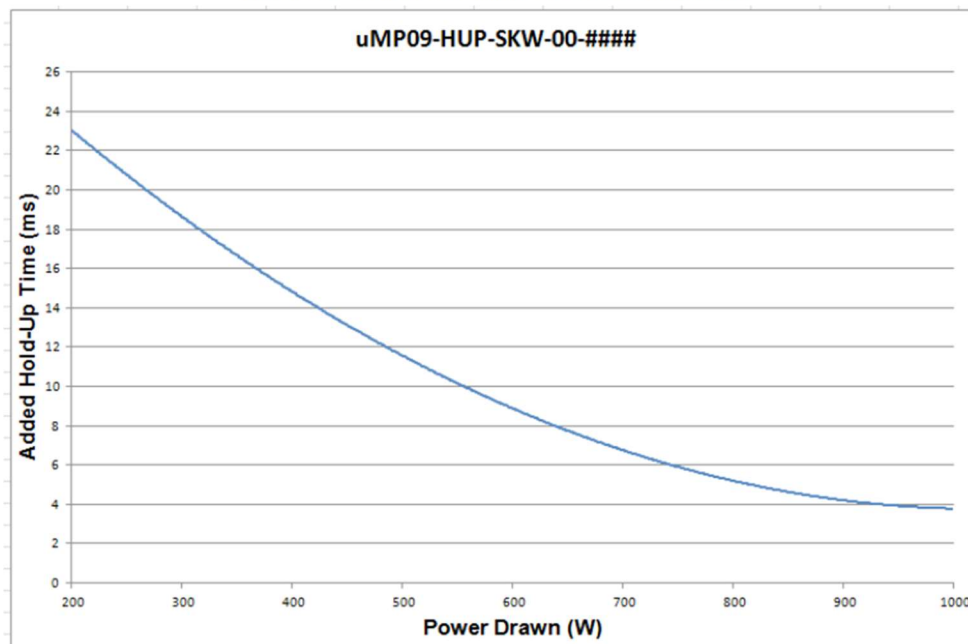

ELECTRICAL SPECIFICATIONS

System Timing Specifications

Table 12. System Timing Specifications					
Label	Parameter	Min	Typ	Max	Unit
T1	Delay from AC being applied to V_{SB} being within regulation	-	-	1500	mSec
T2	Delay from AC being applied to output voltages being within regulation.	-	-	2000	mSec
T3	V_O rise time, 10% V_O to V_O in regulation	-	-	50	mSec
T4	Delay from output voltages within regulation limits to Global DC OK asserted high. Measured from last module going to regulation to Global DC OK assertion	-	-	20	mSec
T5	Delay from loss of AC to de-assertion of Global DC OK	15	-	-	mSec
T6	Delay from Global DC OK de-asserted to output voltages dropping out of regulation limits.	1			mSec
T7	Hold up time - time all output voltages, including V_{SB} , stay within regulation after loss of AC.	16.7	-	-	mSec
T8	Delay from V_{SB} being within regulation to output voltages being within regulation.	50	-	2000	mSec

ELECTRICAL SPECIFICATIONS

System Timing Diagram

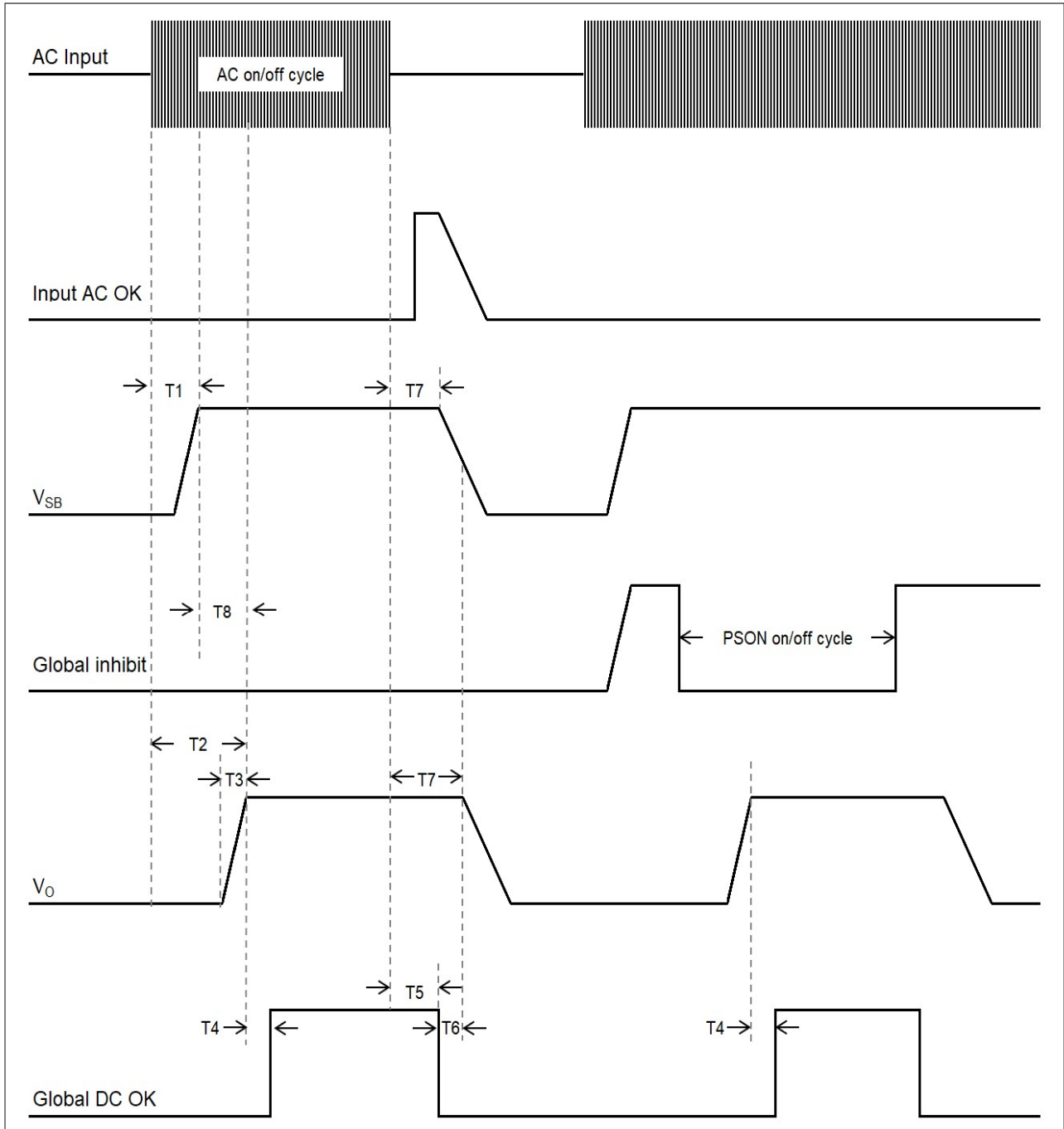

ELECTRICAL SPECIFICATIONS

μMP04 Case Performance Curves

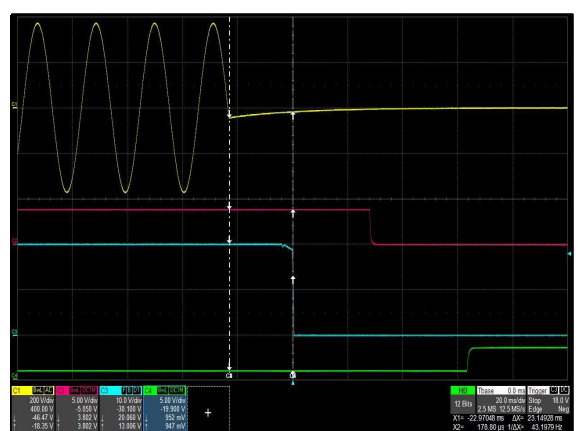
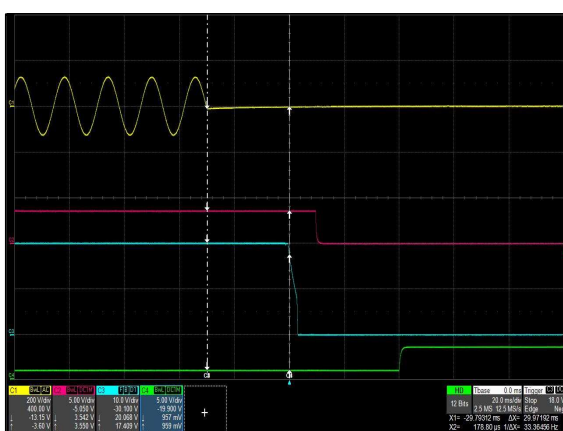
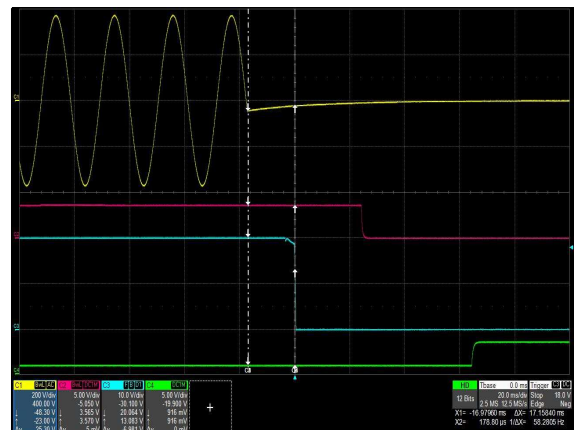
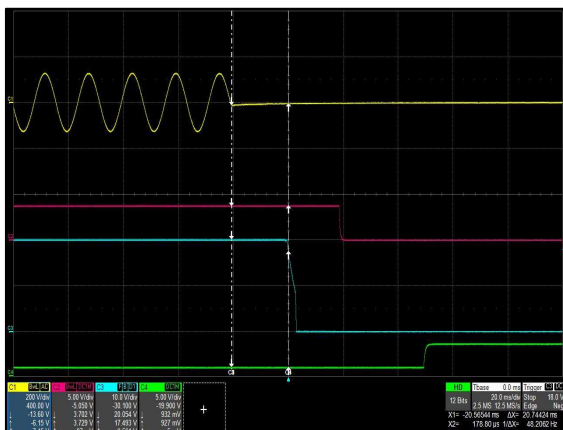
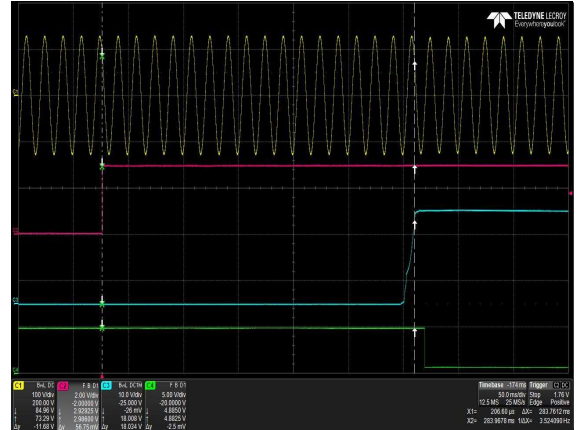
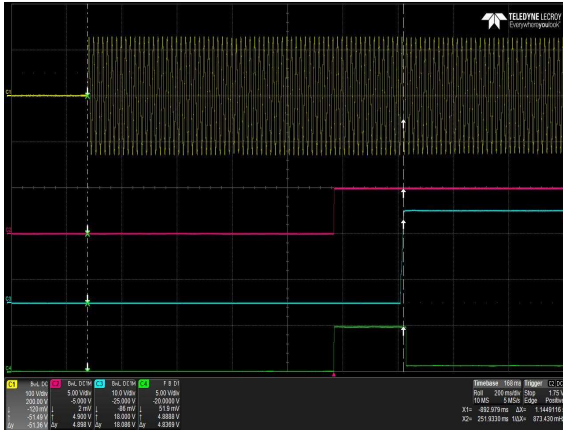

ELECTRICAL SPECIFICATIONS

μMP04 Case Performance Curves



Figure 7: μMP04T-S2P-S2P-S2P-60-A Start up Inrush Current
 Vin = 264Vac Load: I_O = 0A I_{SB} = 0A Turn On Phase = 90°
 Ch 1: V_{IN} Ch 2: I_{IN}

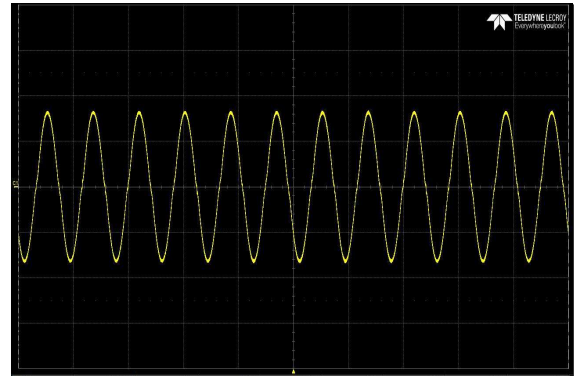

Figure 8: μMP04T-S2P-S2P-S2P-60-A Input Current Waveform
 Vin = 90Vac Load: I_O = 20A I_{SB} = 1A
 Ch 1: I_{IN}

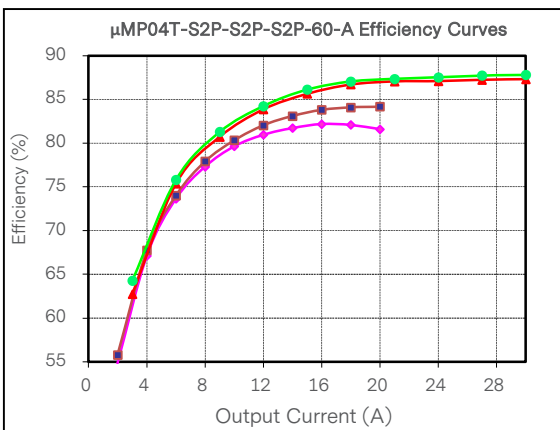
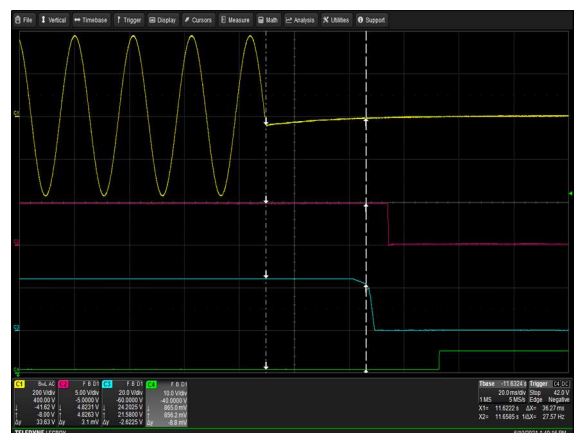
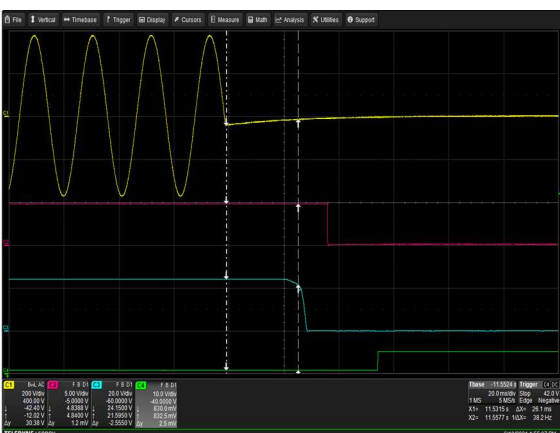
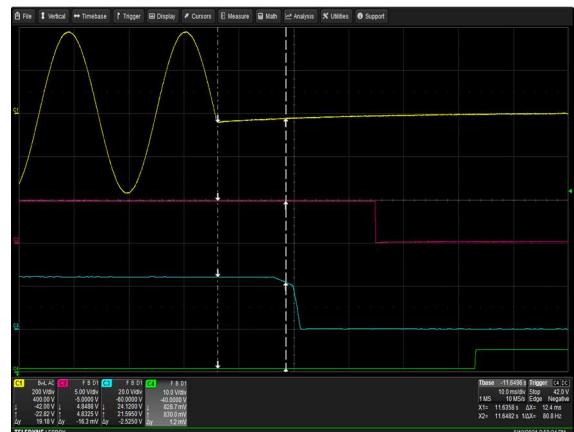

Figure 9: μMP04T-S2P-S2P-S2P-60-A Efficiency Curve @ 25°C
 Loading: I_{o_main} = 10%I_{o_max} increment to 30A, I_{SB} = 0A

ELECTRICAL SPECIFICATIONS

μMP09 Case Performance Curves



ELECTRICAL SPECIFICATIONS

μMP09 Case Performance Curves

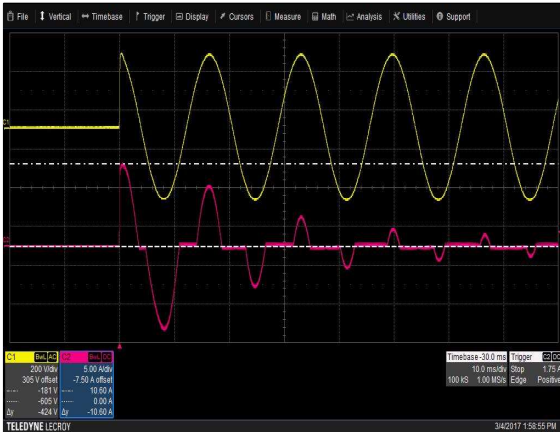

Figure 16: μMP09T-SKQ-S2Q-30-A Start up Inrush Current
 Vin = 264Vac Load: I_O = 0A I_{SB} = 0A Turn On Phase = 90°
 Ch 1: V_{IN} Ch 2: I_{IN}

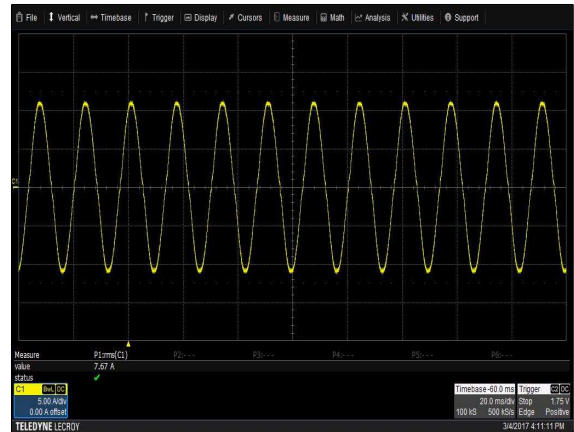

Figure 17: μMP09T-SKQ-S2Q-30-A Input Current Waveform
 Vin = 90Vac Load: I_O = 23A I_{SB} = 2A
 Ch 1: I_{IN}

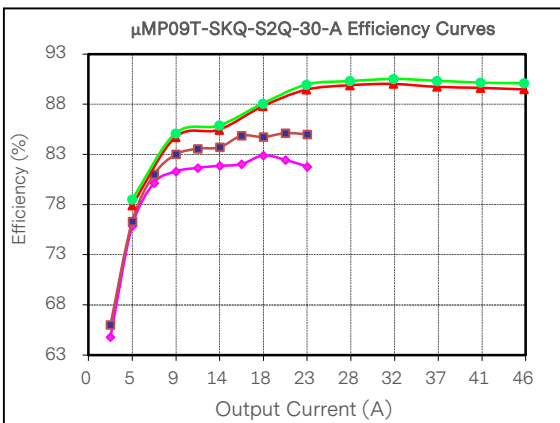

Figure 18: μMP09T-SKQ-S2Q-30-A Efficiency Curve @ 25°C
 Loading: I_{O,main} = 10% I_{O,max} increment to 45.8A, I_{SB} = 0A

ELECTRICAL SPECIFICATIONS

μMP10 Case Performance Curves

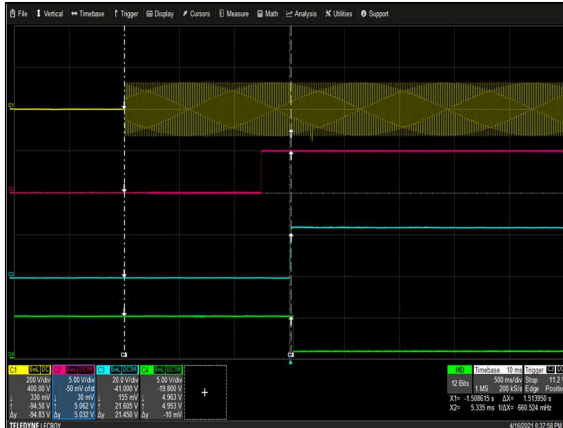

Figure 19: μMP10T-S2Q-S2Q-S2Q-S2Q-S2Q-S2Q-90-A Turn-on delay via AC mains Vin = 90Vac Load: I_O = 41.66A I_{SB} = 2A
Ch 1: AC Mains Ch 2: V_{SB} Ch 3: V_O Ch 4: Global DCOK



Figure 20: μMP10T-S2Q-S2Q-S2Q-S2Q-S2Q-S2Q-90-A Turn-on delay via Global inhibit Vin = 90Vac Load: I_O = 41.66A I_{SB} = 2A
Ch 1: AC Mains Ch 2: Global inhibit Ch 3: V_O Ch 4: Global DCOK



Figure 21: μMP10T-S2Q-S2Q-S2Q-S2Q-S2Q-S2Q-90-A Hold-up Time via AC mains Vin = 90Vac/63Hz Load: I_O = 41.66A I_{SB} = 2A
Ch 1: AC Mains Ch 2: V_{SB} Ch 3: V_O Ch 4: Global DCOK

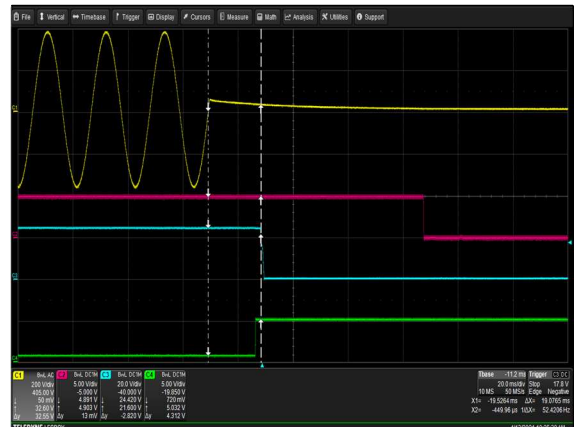

Figure 22: μMP10T-S2Q-S2Q-S2Q-S2Q-S2Q-S2Q-90-A Hold-up Time via AC mains Vin = 264Vac/47Hz Load: I_O = 50A I_{SB} = 2A
Ch 1: AC Mains Ch 2: V_{SB} Ch 3: V_O Ch 4: Global DCOK

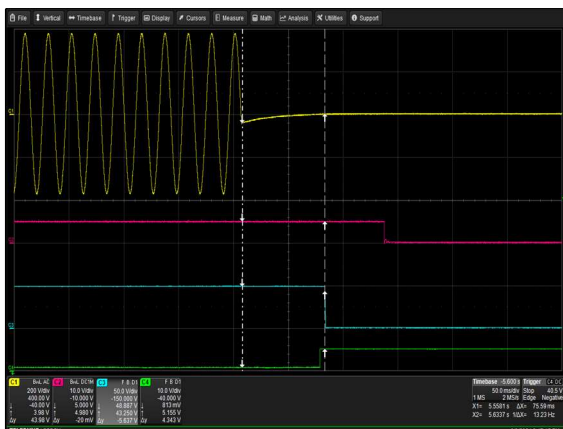

Figure 23: μMP10T-S2W-00-A Hold-up Time
Vin = 264Vac/47Hz Load: I_O = 5A I_{SB} = 2A
Ch 1: AC Mains Ch 2: V_{SB} Ch 3: V_O Ch 4: Global DCOK

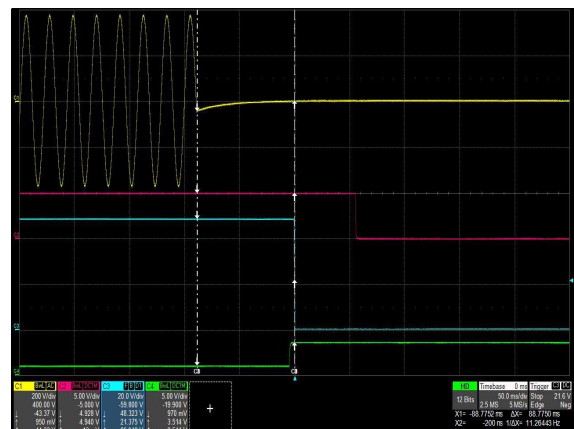

Figure 24: μMP10T-S2W-HUP-00-A Hold-up Time
Vin = 264Vac/47Hz Load: I_O = 5A I_{SB} = 2A
Ch 1: AC Mains Ch 2: V_{SB} Ch 3: V_O Ch 4: Global DCOK

ELECTRICAL SPECIFICATIONS

μMP10 Case Performance Curves

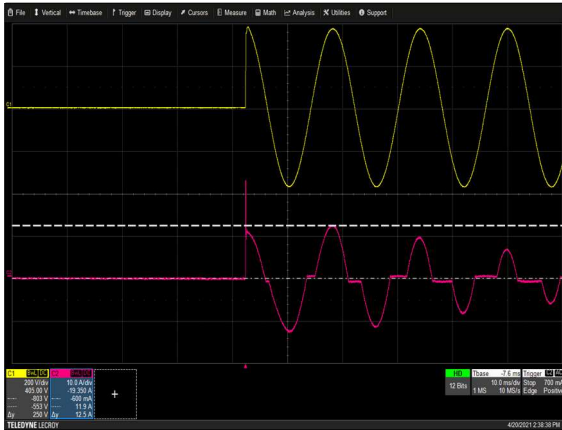

Figure 25: μMP10T-S2Q-S2Q-S2Q-S2Q-S2Q-90-A Start up Inrush Current Vin = 264Vac Load: Io = 50A I_{SB} = 0A Turn On Phase = 90° Ch 1: V_{IN} Ch 2: I_{IN}

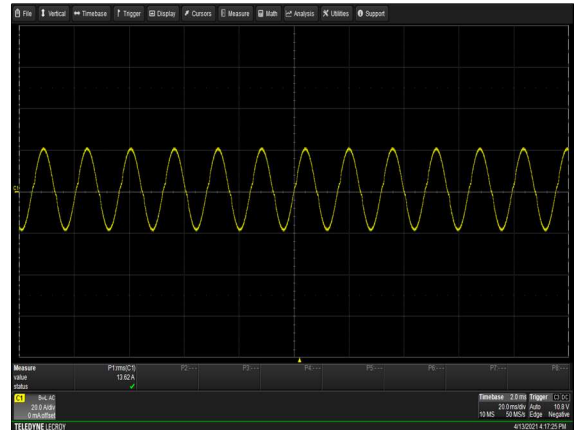

Figure 26: μMP10T-S2Q-S2Q-S2Q-S2Q-S2Q-90-A Input Current Waveform Vin = 90Vac Load: Io = 41.66A I_{SB} = 2A Ch 1: I_{IN}



Figure 27: μMP10T-S2Q-S2Q-S2Q-S2Q-S2Q-90-A AC OK Delay - Turn on Vin = 90Vac Load: Io = 41.66A Ch 1: V_{IN} Ch2: Input AC OK Ch3: Global DC OK Ch4: V_O



Figure 28: μMP10T-S2Q-S2Q-S2Q-S2Q-S2Q-90-A AC OK Delay - Turn off Vin = 90Vac Load: Io = 41.66A Ch 1: V_{IN} Ch2: Input AC OK Ch3: Global DC OK Ch4: V_O

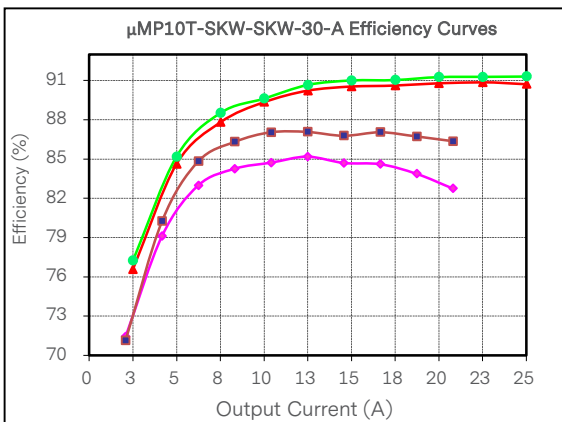

Figure 29: μMP10T-SKW-SKW-30-A Efficiency Curve @ 25°C
 Loading: I_{o,main} = 10%I_{o,max} increment to 25A, I_{SB} = 0A

ELECTRICAL SPECIFICATIONS

μMP16 Case Performance Curves

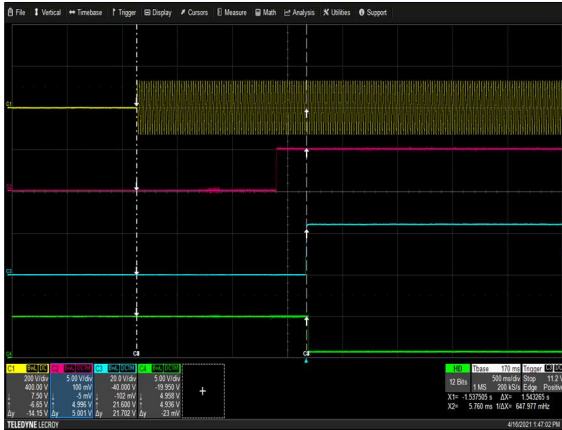

Figure 30: μMP16C-SKQ-SKQ-30-A Turn-on delay via AC mains
 $V_{in} = 90V_{ac}$ Load: $I_o = 41.66A$ $I_{SB} = 2A$
 Ch 1: AC Mains Ch 2: V_{SB} Ch 3: V_O Ch 4: Global DCOK

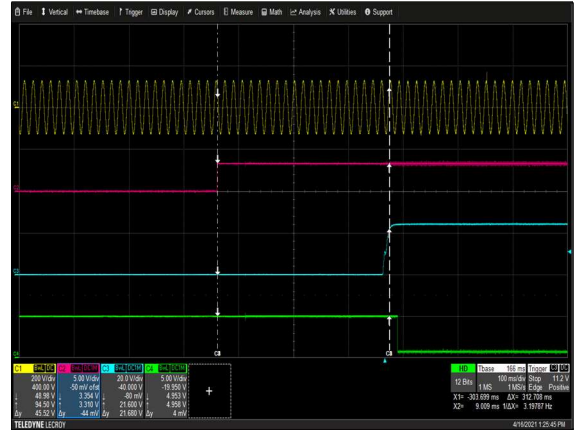

Figure 31: μMP16C-SKQ-SKQ-30-A Turn-on delay via Global inhibit
 $V_{in} = 90V_{ac}$ Load: $I_o = 41.66A$ $I_{SB} = 2A$
 Ch 1: AC Mains Ch 2: Global inhibit Ch 3: V_O Ch 4: Global DCOK



Figure 32: μMP16C-SKQ-SKQ-30-A Hold-up Time
 $V_{in} = 90V_{ac}/63Hz$ Load: $I_o = 41.66$ $I_{SB} = 2A$
 Ch 1: AC Mains Ch 2: V_{SB} Ch 3: V_O Ch 4: Global DCOK



Figure 33: μMP16C-SKQ-SKQ-30-A Hold-up Time
 $V_{in} = 264V_{ac}/47Hz$ Load: $I_o = 75A$ $I_{SB} = 2A$
 Ch 1: AC Mains Ch 2: V_{SB} Ch 3: V_O Ch 4: Global DCOK

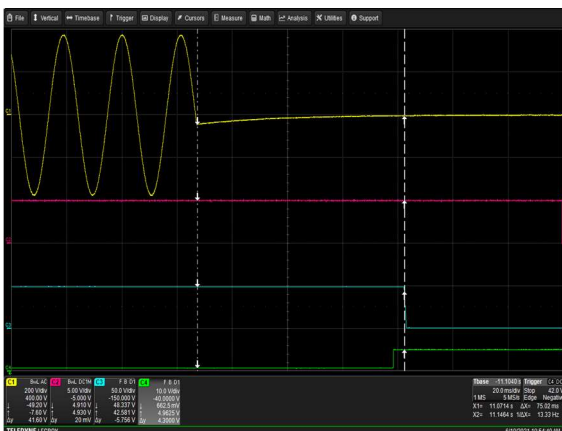

Figure 34: μMP16C-S2W-00-A Hold-up Time
 $V_{in} = 264V_{ac}/47Hz$ Load: $I_o = 5A$ $I_{SB} = 2A$
 Ch 1: AC Mains Ch 2: V_{SB} Ch 3: V_O Ch 4: Global DCOK

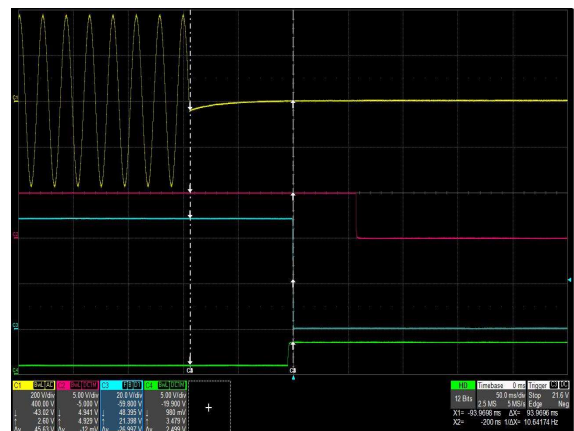

Figure 35: μMP16C-S2W-HUP-00-A Hold-up Time
 $V_{in} = 264V_{ac}/47Hz$ Load: $I_o = 5A$ $I_{SB} = 2A$
 Ch 1: AC Mains Ch 2: V_{SB} Ch 3: V_O Ch 4: Global DCOK

ELECTRICAL SPECIFICATIONS

μMP16 Case Performance Curves

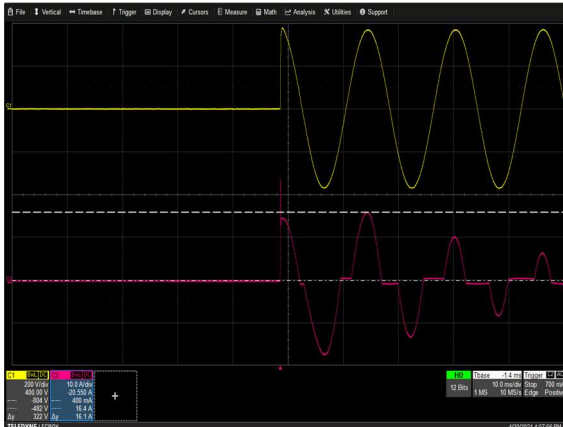

Figure 36: μMP16C-SKQ-SKQ-30-A Start up Inrush Current
 Vin = 264Vac Load: Io = 75A I_{SB} = 2A Turn On Phase = 90°
 Ch 1: V_{IN} Ch 2: I_{IN}

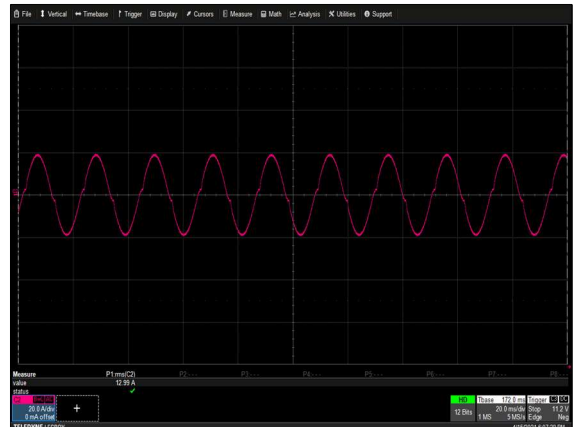

Figure 37: μMP16C-SKQ-SKQ-30-A Input Current Waveform
 Vin = 90Vac Load: Io = 41.66A I_{SB} = 2A
 Ch 1: I_{IN}

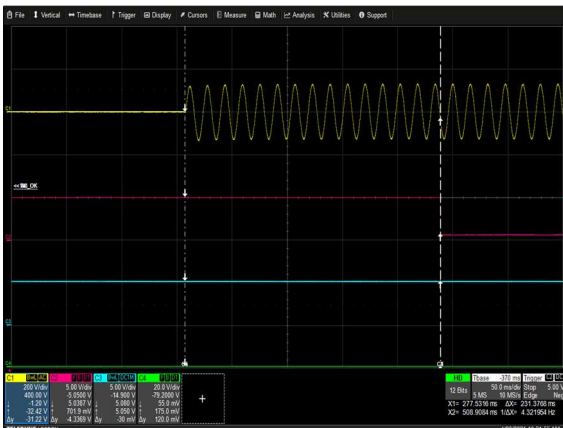

Figure 38: μMP16C-SKQ-SKQ-30-A AC OK Delay - Turn on
 Vin = 90Vac Load: Io = 41.66A I_{SB} = 0A Turn On Phase = 90°
 Ch 1: V_{IN} Ch 2: Input AC OK Ch 3: Global DC OK Ch 4: V_o

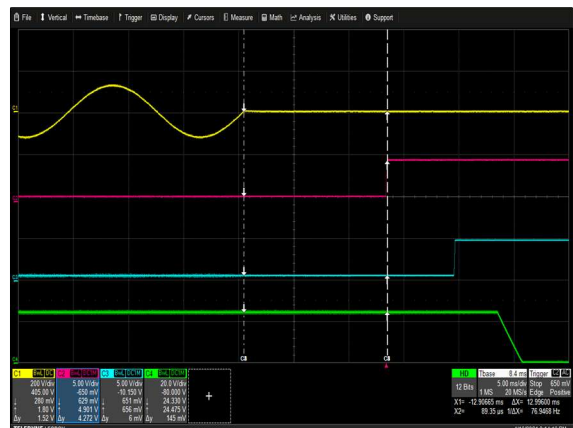

Figure 39: μMP16C-SKQ-SKQ-30-A AC OK Delay - Turn off
 Vin = 90Vac Load: Io = 41.66A I_{SB} = 0A Turn On Phase = 90°
 Ch 1: V_{IN} Ch 2: Input AC OK Ch 3: Global DC OK Ch 4: V_o

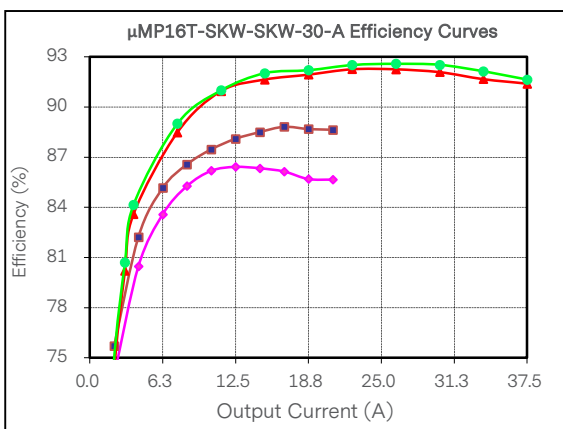

Figure 40: μMP16T-SKW-SKW-30-A Efficiency Curve @ 25°C
 Loading: I_{o,main} = 10% I_{o,max} increment to 37.5A, I_{SB} = 0A

ELECTRICAL SPECIFICATIONS

240W 12V Module Performance Curves

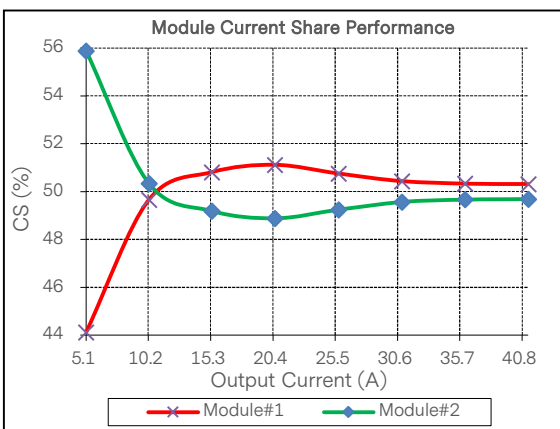
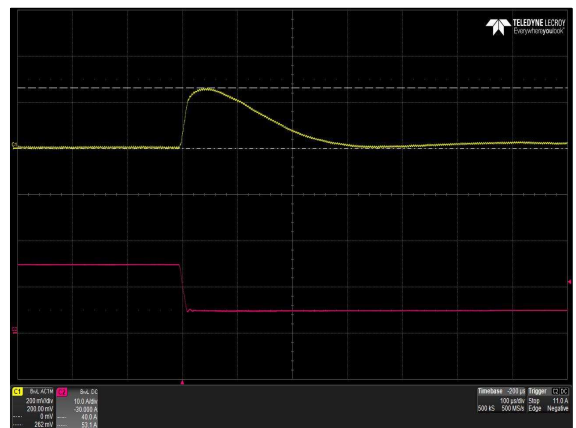
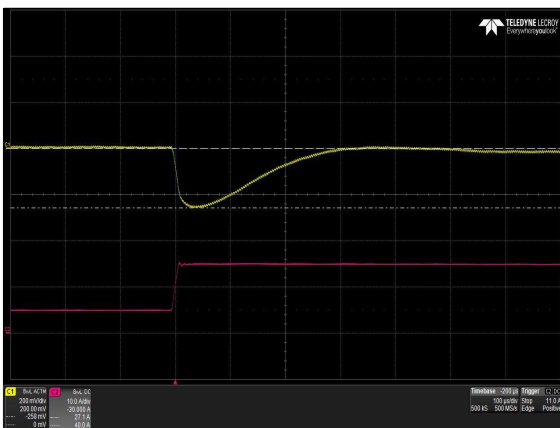
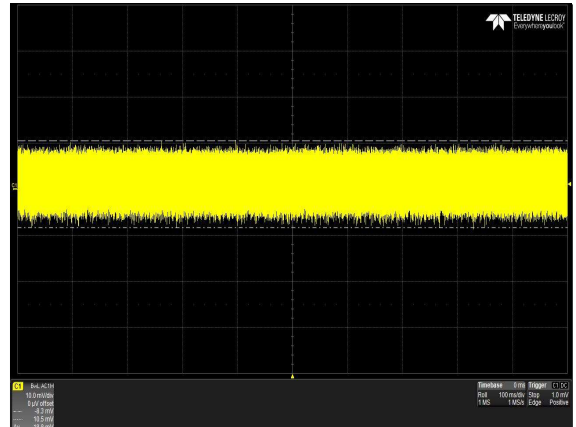
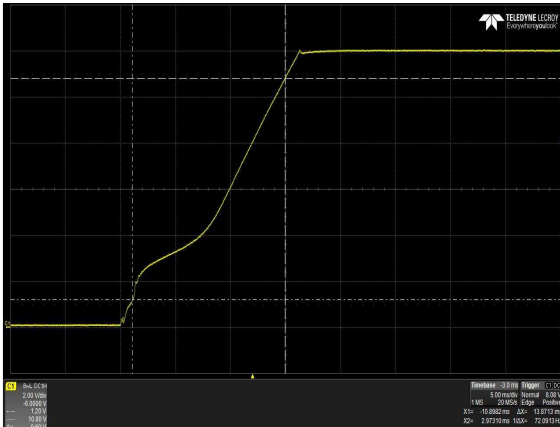

Figure 45: μMP16T-S2L-S2L-10-A Current Share Performance

ELECTRICAL SPECIFICATIONS

1000W 48V Module Performance Curves

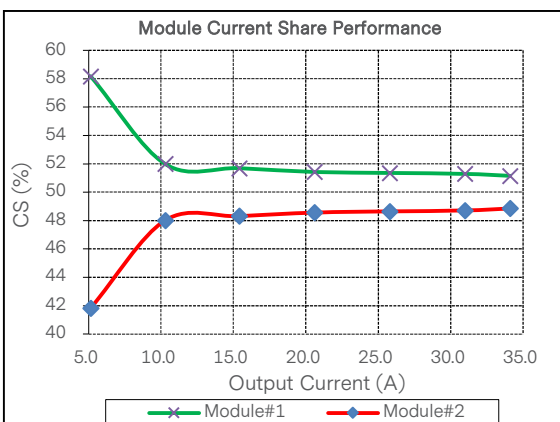
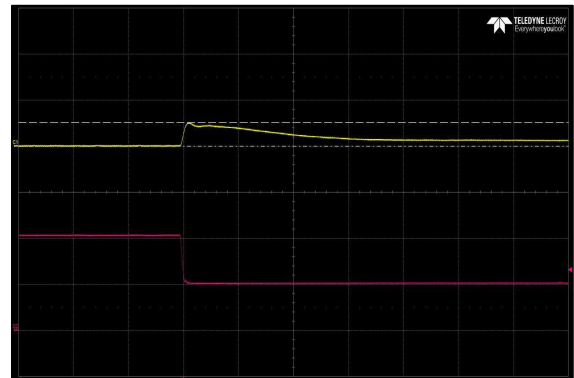
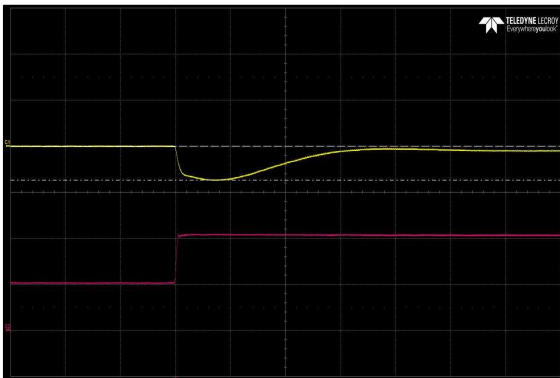
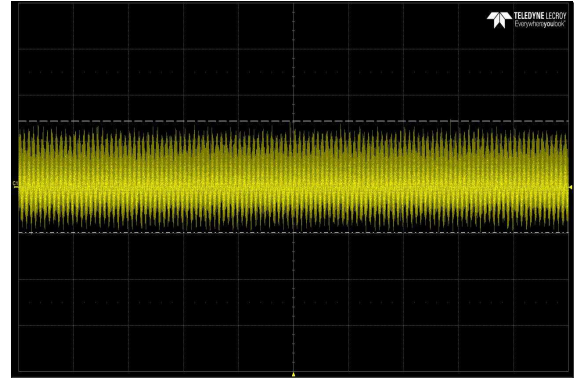
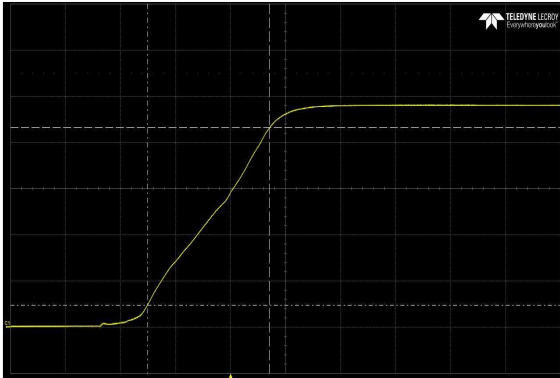

Figure 50: μMP16T-SKW-SKW-30-A Current Share Performance

ELECTRICAL SPECIFICATIONS

96W Dual ISO Module Performance Curves

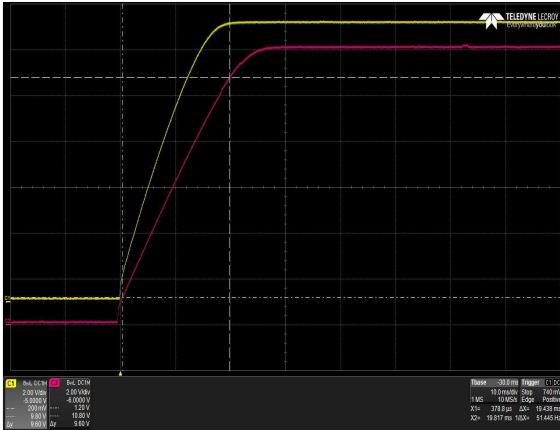

Figure 51: μMP16T-ILL-00-A Output Voltage Startup Characteristic
 Load: $I_{O1} = 4A, I_{O2} = 4A$
 Ch 1: V_{O1} Ch 2: V_{O2}

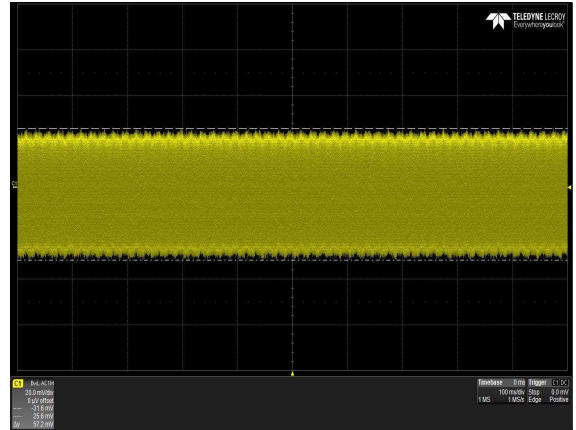

Figure 52: μMP16T-ILL-00-A Ripple and Noise Measurement
 Load: $I_{O1} = 4A$
 Ch 1: V_{O1}

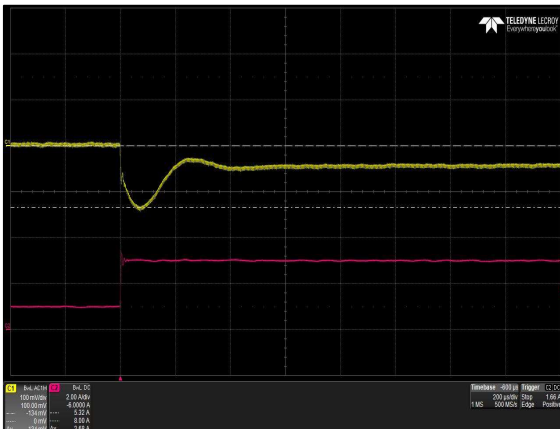

Figure 53: μMP16T-ILL-00-A Transient Response - V_O Deviation
 25% to 75% load change, $1A/\mu s$ slew rate, $C_O = 470\mu F$
 Ch 1: V_{O1} Ch 2: I_{O1}

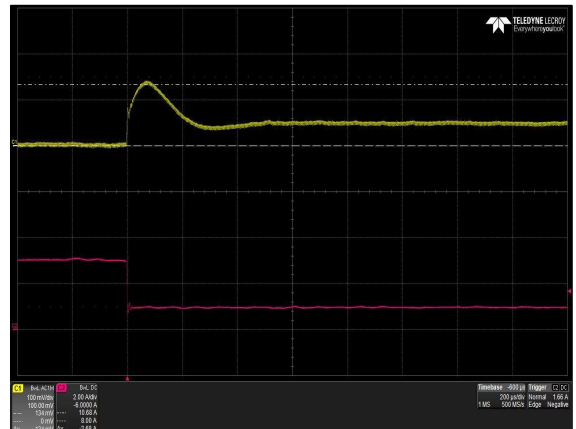

Figure 54: μMP16T-ILL-00-A Transient Response - V_O Deviation
 75% to 25% load change, $1A/\mu s$ slew rate, $C_O = 470\mu F$
 Ch 1: V_{O1} Ch 2: I_{O1}

ELECTRICAL SPECIFICATIONS

Protection Function Specifications

Input Fuse

μMP Series is equipped with an internal non user serviceable 16A (TLAG) 250 Vac fuse for μMP10/μMP16, 10A (TLAG) 250 Vac for μMP04/μMP09 for fault protection in both the L1 and L2 lines input.

Over Voltage Protection (OVP)

The power supply latches off during output overvoltage with the AC line recycled to reset the latch.

Parameter	Min	Nom	Max	Unit
3.3 V Module				
0.9 V Output Overvoltage	-	-	2.00	V
3.3 V Output Overvoltage	-	-	5.96	V
3.6 V Output Overvoltage	-	-	6.31	V
5 V Module				
3.2 V Output Overvoltage	-	-	5.76	V
5 V Output Overvoltage	-	-	9.00	V
6 V Output Overvoltage	-	-	10.80	V
12 V Module				
6 V Output Overvoltage	-	-	10.80	V
12 V Output Overvoltage	-	-	15.60	V
15 V Output Overvoltage	-	-	19.50	V
24 V Module				
12 V Output Overvoltage	-	-	15.60	V
24 V Output Overvoltage	-	-	31.20	V
30 V Output Overvoltage	-	-	39.00	V
48 V Module				
28 V Output Overvoltage	-	-	36.40	V
48 V Output Overvoltage	-	-	62.40	V
60 V Output Overvoltage	-	-	78.00	V

ELECTRICAL SPECIFICATIONS

Over Current Protection (OCP)

μMP series includes internal current limit circuitry to prevent damage in the event of overload or short circuit. Recovery is automatic when the overload is removed. It is constant current type.

5 V housekeeping will shutdown with excessive load > 1.5A during convection-cooled inhibit mode. It will automatically recover after some delay when excessive load is removed.

Parameter	Min	Nom	Max	Unit
3.3 V Module				
0.9 V Output Over Current	105	130	160	%
3.3 V Output Over Current	105	130	160	%
3.6 V Output Over Current	105	130	160	%
5 V Module				
3.2 V Output Over Current	105	130	160	%
5 V Output Over Current	105	130	160	%
6 V Output Over Current	105	130	160	%
12 V Module				
6 V Output Over Current	105	130	160	%
12 V Output Over Current	105	130	160	%
15 V Output Over Current	105	130	160	%
24 V Module				
12 V Output Over Current	105	130	160	%
24 V Output Over Current	105	130	160	%
30 V Output Over Current	105	130	160	%
48 V Module				
28 V Output Over Current	105	130	200	%
48 V Output Over Current	105	130	160	%
60 V Output Over Current	105	130	200	%

ELECTRICAL SPECIFICATIONS

Short Circuit Protection (SCP)

The μMP series power supply will withstand a continuous short circuit its main output during start-up or while running. There is no permanent damage when the power supply is SCP.

Over Temperature Protection (OTP)

The μMP series power supply is internally protected against over temperature conditions. When over temperature circuit is activated, the power supply output will disable. Recovery type will be auto-recovery with temperature hysteresis.

MECHANICAL SPECIFICATIONS

μMP Series Mechanical Outlines (unit: mm)

μMP04 (400/600 Watts Max), μMP09 (550/1100 Watts Max)

Case Size: μMP04/μMP09: 10.11" x 3.5" x 1.57" (256.9 mm x 88.9 mm x 40.0 mm)

Weight: μMP04 Case: 1.96 lbs (889g), μMP09 Case: 2.47 lbs (1120.4g)

Acoustic Noise: μMP04/μMP09 < 35dbA at 50% case output power under 25°C

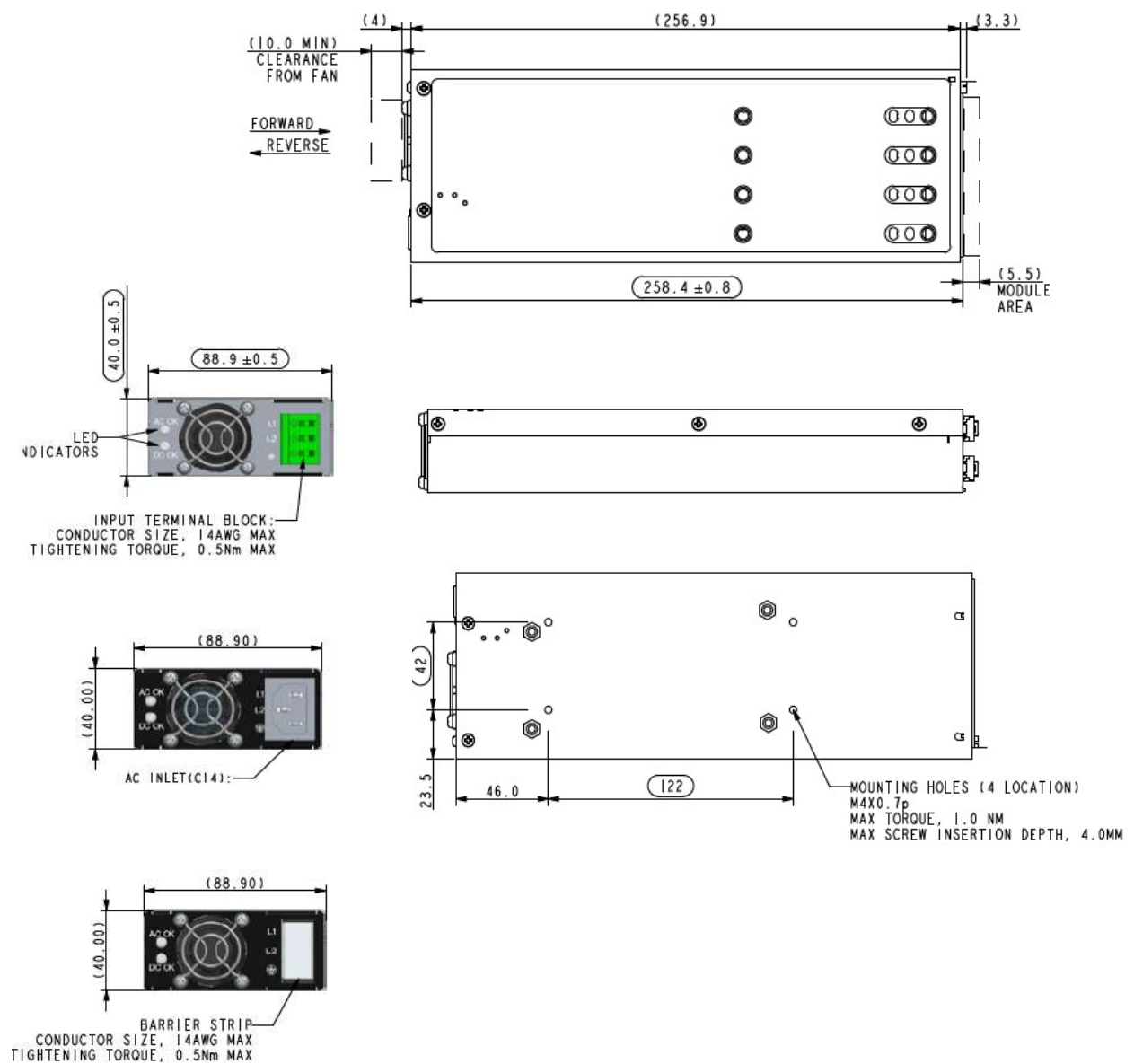

MECHANICAL SPECIFICATIONS

μMP Series Mechanical Outlines

Case Input Types:

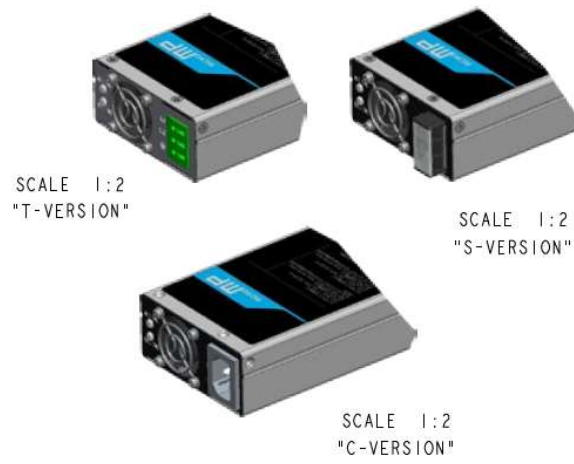

Module Slot Location:

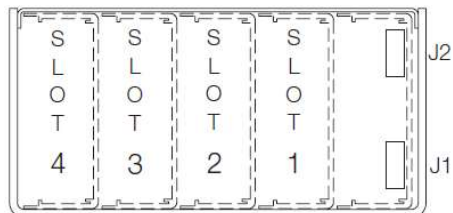

MECHANICAL SPECIFICATIONS

μMP Series Mechanical Outlines (unit: mm)

μMP10 (1000/1200 Watts Max)

μMP16 (1200/1800 Watts Max)

Case Size: μMP10/16: 10.11" x 5" x 1.57" (256.9 mm x 127 mm x 40.0 mm)

Weight: μMP10/16 Case: 2.78 lbs (1261g)

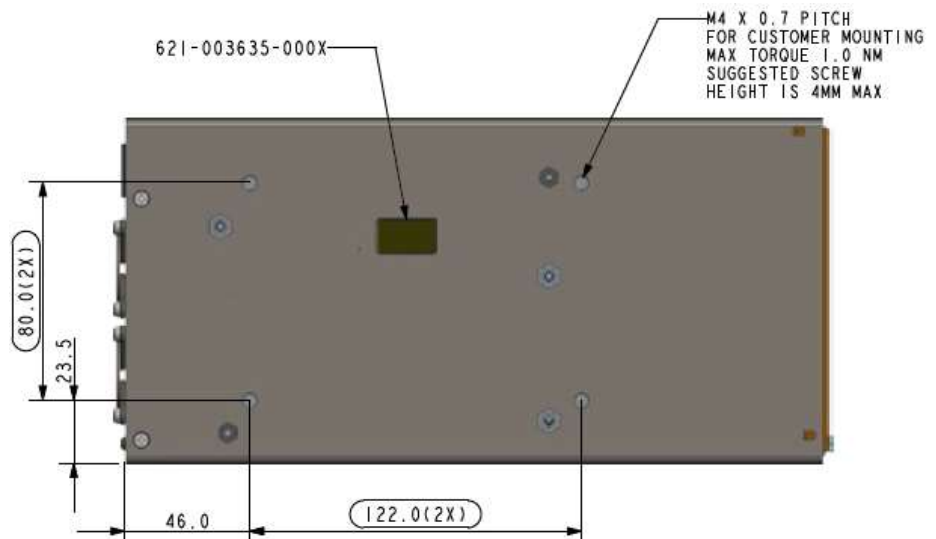
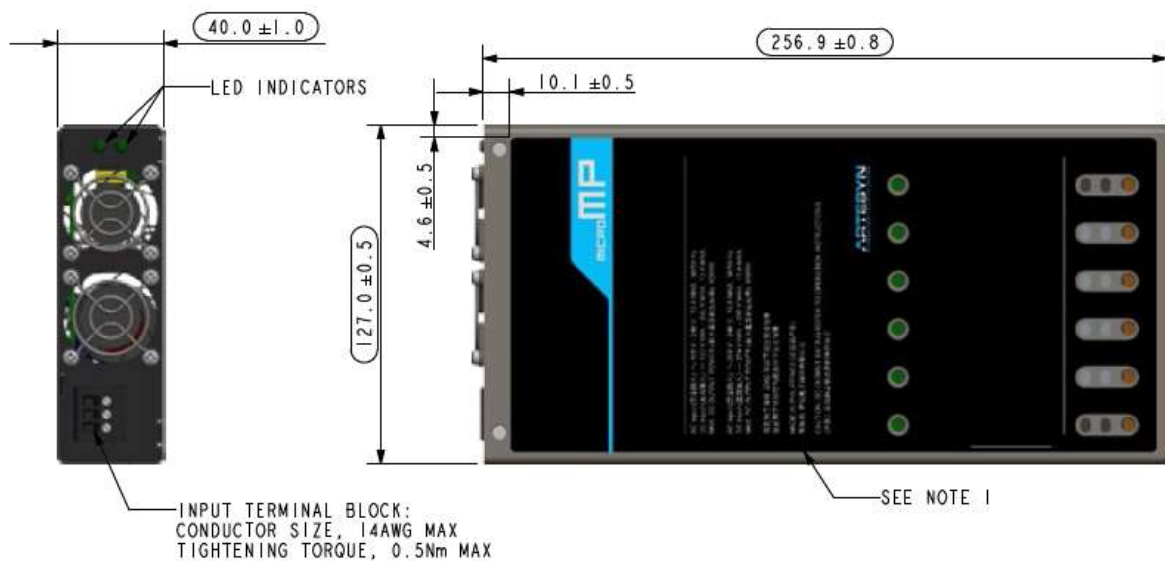

MECHANICAL SPECIFICATIONS

μMP Series Mechanical Outlines

Case Input Types:

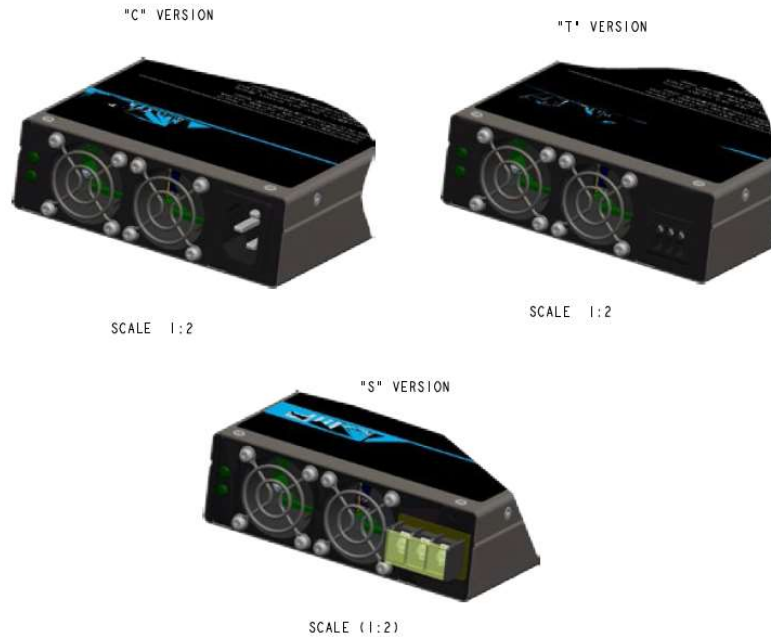

Module Slot Location:

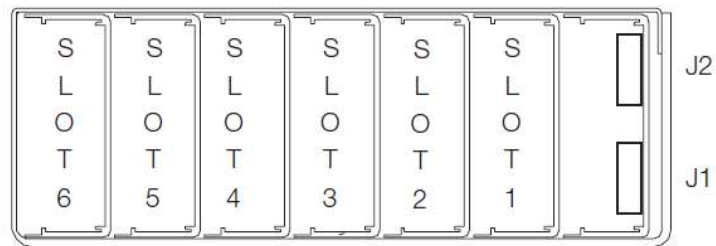

MECHANICAL SPECIFICATIONS

S2 Module Mechanical Outlines (unit: mm)

Weight: 200W Single O/P: 0.22lb (99.8g)

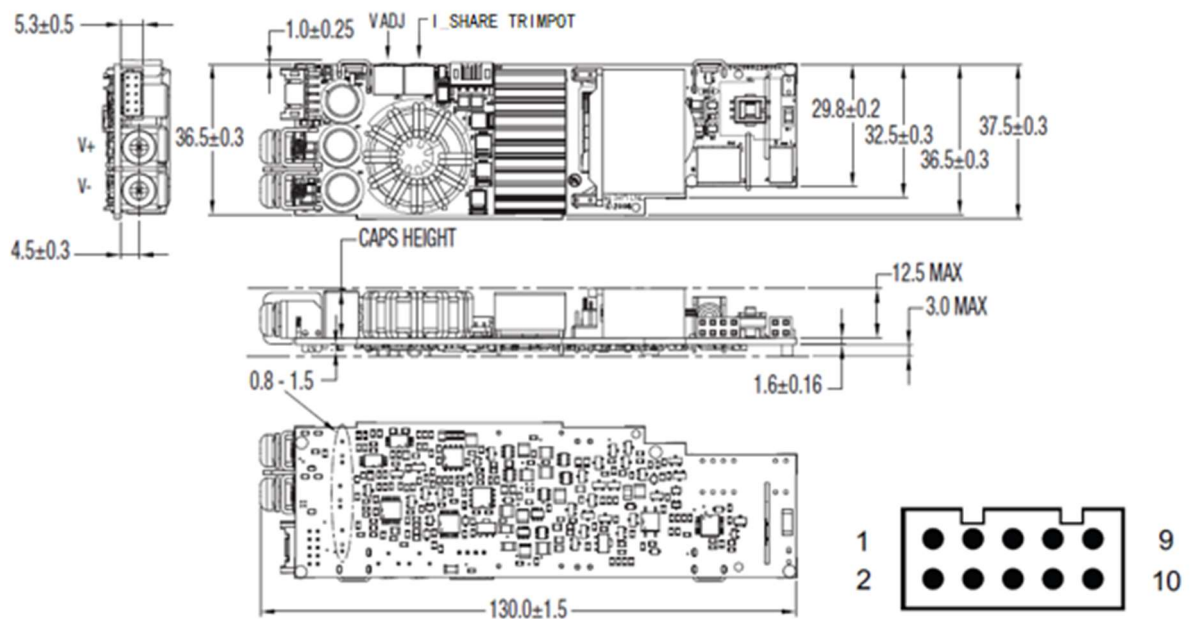

MECHANICAL SPECIFICATIONS

SK Module Mechanical Outlines (unit: mm)

Weight: 1000W Single O/P: 0.91lb (412.8g)

12/24V Output

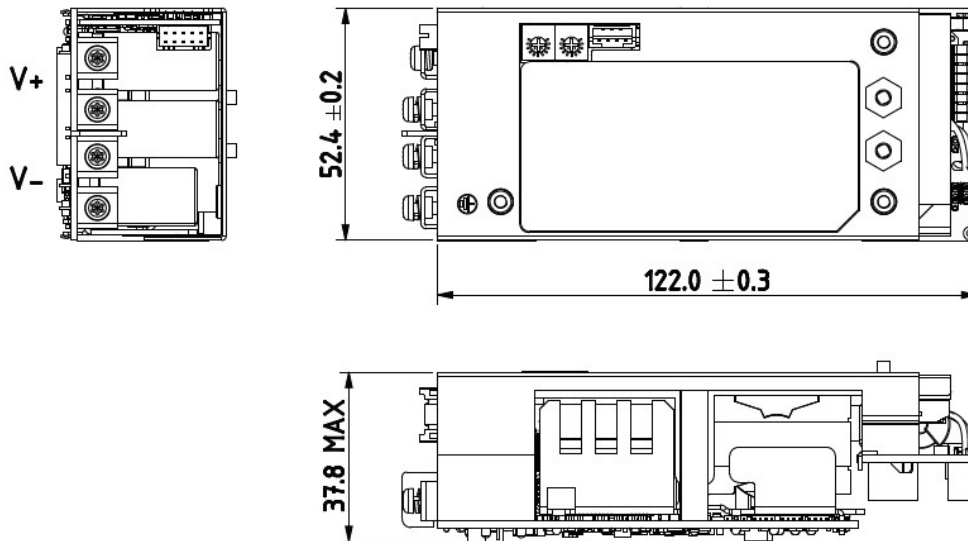
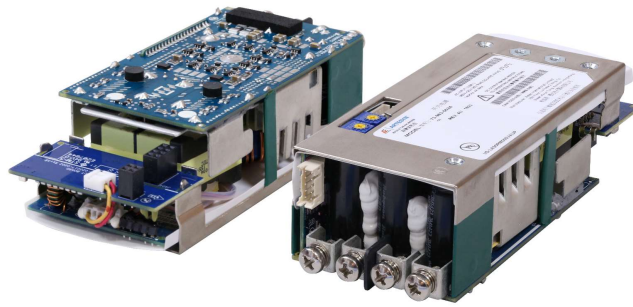

MECHANICAL SPECIFICATIONS

48V Output

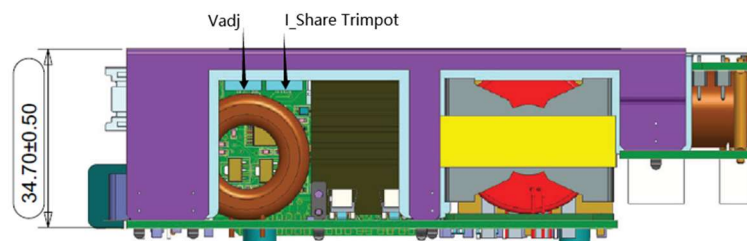
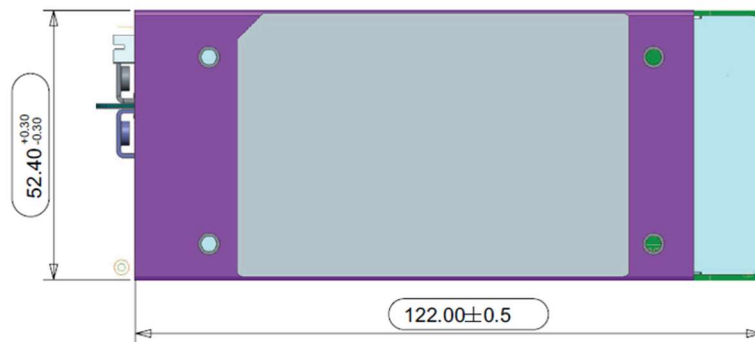

MECHANICAL SPECIFICATIONS

Dual Module Mechanical Outlines (unit: mm)

Weight: Dual O/P: 0.16lb (72.6g)

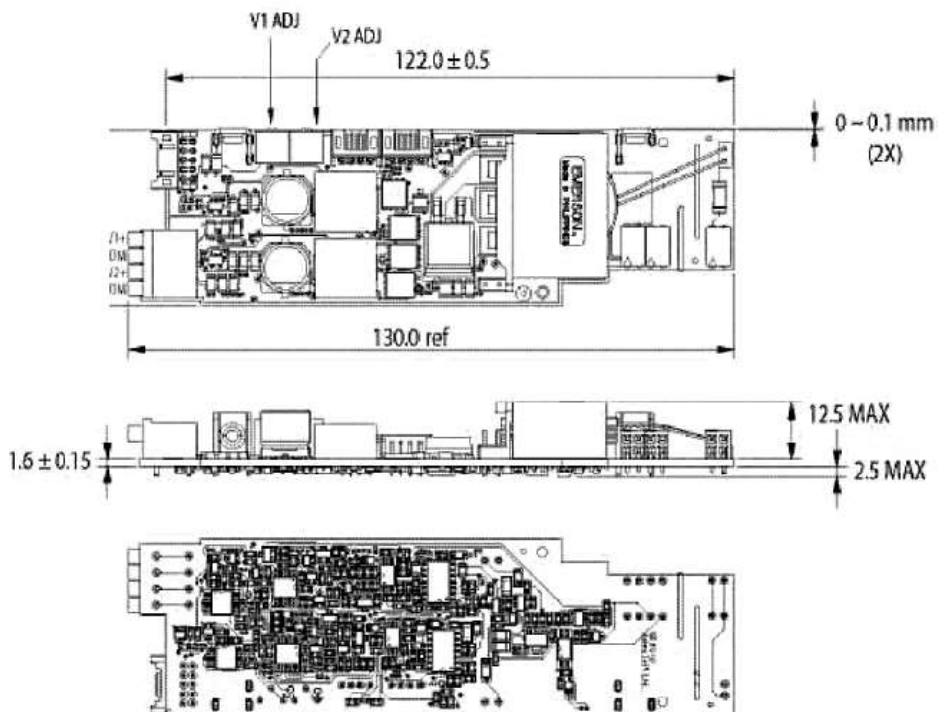

MECHANICAL SPECIFICATIONS

HUP Module Mechanical Outlines (unit: mm)

Weight: 0.16lb (72.6g)



73-950-002

Actual μMP HUP Module and μMP09 Configuration



μMP09 Config with HUP at Slot1

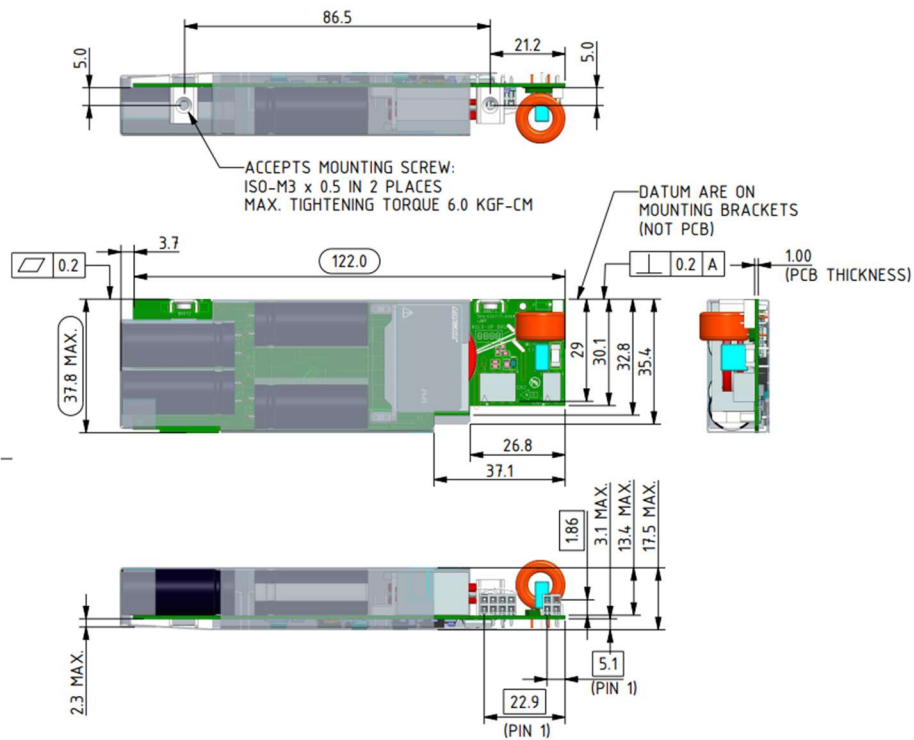

MECHANICAL SPECIFICATIONS

Connector Definitions - Case

AC Input Connector

Pin 1 – AC Neutral

Pin 2 – AC Line(hot)

Pin 3 – Chassis (earth) ground

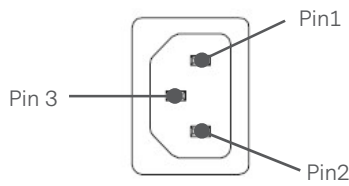

IEC Connector

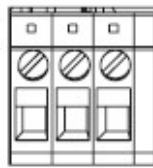

Terminal Block

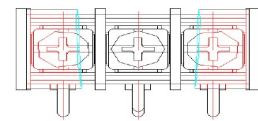

Barrier Strip

Case Control Signal Connector - J1

Pin 1 – Input AC OK - “emitter”

Pin 2 – Input AC OK - “collector”

Pin 3 – Global DC OK - “emitter”

Pin 4 – Global DC OK - “collector”

Pin 5 – Spare

Pin 6 – Global inhibit/optional enable logic “1”

Pin 7 – Global inhibit/optional enable logic “0”

Pin 8 – Global inhibit/optional enable return

Pin 9 – +5VSB housekeeping

Pin 10 – +5VSB housekeeping return

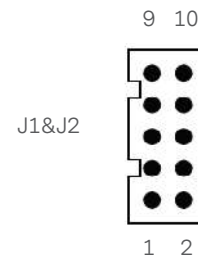

Case I²C Bus Signal Connector - J2

Pin 1 – 5Vcc bus

Pin 2 – Serial data signal (SDA)

Pin 3 – Secondary return (COM)

Pin 4 – Serial clock signal (SCL)

Pin 5 – Address bit 2 (A2)

Pin 6 – No connection

Pin 7 – Address bit 1 (A1)

Pin 8 – No connection

Pin 9 – Address bit 0 (A0)

Pin 10 – No connection

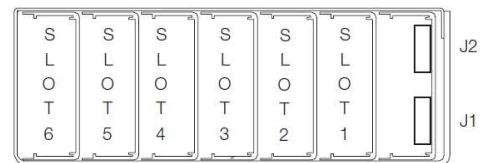
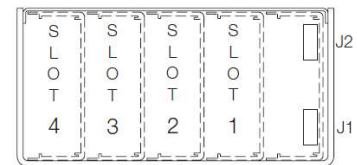

MECHANICAL SPECIFICATIONS

Connector Definitions - S2# & SK# Module

Main Output Terminals

V+ – Positive Output

V- – Negative Output

DC Output Control Signal Connector

Pin 1 – No connection

Pin 2 – No connection

Pin 3 – Current share

Pin 4 – Module inhibit return

Pin 5 – Module ISO inhibit

Pin 6 – SCOM

Pin 7 – -RMT sense

Pin 8 – Margin

Pin 9 – Remote margin / V prog.

Pin 10 – +RMT sense

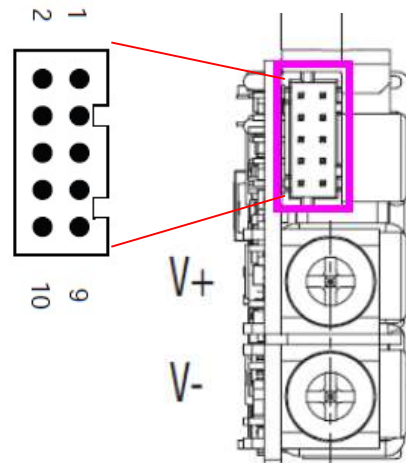

MECHANICAL SPECIFICATIONS

Connector Definitions - I## Module

Main Output Terminals

- V1+ – V1 Positive Output
- Com – V1 Negative Output
- V2+ – V2 Positive Output
- Com – V2 Negative Output

DC Output Control Signal Connector

- Pin 1 – -RMT sense V2
- Pin 2 – +RMT sense V2
- Pin 3 – No connection
- Pin 4 – Module inhibit rtn
- Pin 5 – Module ISO inhibit
- Pin 6 – SCOM
- Pin 7 – -RMT sense V1
- Pin 8 – No connection
- Pin 9 – No connection
- Pin 10 – +RMT sense V1

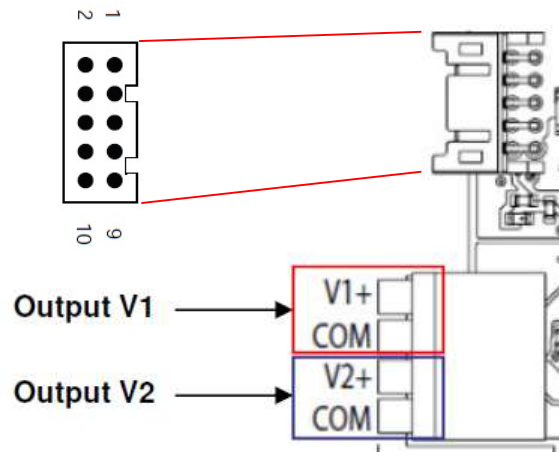

MECHANICAL SPECIFICATIONS

Power / Signal Mating Connectors and Pin Types

Table 13. Mating Connectors for μMP (or equivalent)	
Reference	Mating Connector or Equivalent
AC Input (IEC Connector C14)	IEC Connector C13
DC Output (Barr)	Molex 19141-0058/0063 or 19099/0048 Spade lug based on Cable Ampacity/AWG
Case Control Signal Connector - J1	Landwin 2050S1000 (housing) Landwin 2053T011V (pins) or JST PHDR-10VS(housing) JST SPHD-002T-P0.5(28-24)(pins) JST SPHD-001T-P0.5(26-22)
Case I ² C Bus Signal Connector- J2	Landwin 2050S1000 (housing) Landwin 2053T011V (pins) or JST PHDR-10VS(housing) JST SPHD-002T-P0.5(28-24)(pins) JST SPHD-001T-P0.5(26-22)
DC Output Control Signal Connector	Landwin 2050S1000 (housing) Landwin 2053T011V (pins) or JST PHDR-10VS(housing) JST SPHD-002T-P0.5(28-24)(pins) JST SPHD-001T-P0.5(26-22)

Note: The Advanced Energy Connector Kit for J1, J2 and DC Output Control Signal Connector is 70-841-023.
The series bus bar for μMP is 500-004342-0000.

MECHANICAL SPECIFICATIONS

LED Indicator Definitions

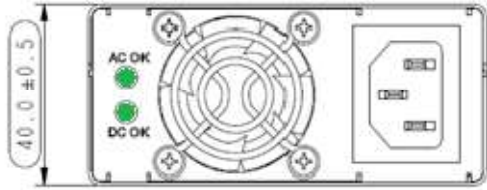

Two (green/off) LEDs are placed on the case fan panel with status conditions are shown on the table below. Each module will have a green LED indicating basic output operation (not driven by DCOK)

Conditions	Case AC OK LED Status	Case DC OK LED Status	Module LED Status
$V_{SB} = ON, V_O = OFF, AC\ Input = ON$	Green	Blinking	OFF
$V_{SB} = ON, V_O = ON$	Green	Green	Green
$V_O = OCP / OVP / SCP$	Green	OFF	OFF
$FAN_FAULT / OTP / V_{SB} = OCP$	Green	OFF	OFF
AC Not Present	OFF	OFF	OFF

ENVIRONMENTAL SPECIFICATIONS

EMC Immunity

μMP series power supply is designed to meet the following EMC immunity specifications.

Table 14. Environmental Specifications	
Document	Description
FCC Part 15 Subpart J Class B/ EN55022, Level B	Conducted and Radiated EMI Limits
EN61000-3-2	Harmonics
EN61000-3-3	Voltage Fluctuations
IEC/EN 61000-4-2	Electromagnetic Compatibility (EMC) - Testing and measurement techniques – Electrostatic discharge immunity test. Level 3, performance Criteria B, otherwise, +/-8KV air, +/-6KV contact discharge for non-standard test points,
IEC/EN 61000-4-3	Electromagnetic Compatibility (EMC) - Testing and measurement techniques, Radiated, radio-frequency, electromagnetic field immunity test. Level 3, Criteria A, Designed to Meet.
IEC/EN 61000-4-4	Electromagnetic Compatibility (EMC) - Testing and measurement techniques, Electrical Fast Transient/Burst Immunity, Level 4, performance Criteria B
IEC/EN 61000-4-5	Electromagnetic Compatibility (EMC) - Testing and measurement techniques – Surge, 2KV common mode and 1KV differential mode, performance criteria A.
IEC/EN 61000-4-11	Electromagnetic Compatibility (EMC) - Testing and measurement techniques : Voltage Dips and Interruptions: 30% reduction for 500ms- Criteria B>95% reduction for 10mS, Criteria A, >95% reduction for 5000mS, Criteria C
EN55024	Information Technology Equipment-Immunity Characteristics, Limits and Method of Measurements.

ENVIRONMENTAL SPECIFICATIONS

Safety Certifications

The μMP series power supply is intended for inclusion in other equipment and the installer must ensure that it is in compliance with all the requirements of the end application. This product is only for inclusion by professional installers within other equipment and must not be operated as a stand-alone product.

Table 15. Safety Certifications for μMP Series Power Supply System	
Standard	Description
UL 62368-1/CAN/CSA C22.2 No. 62368-1	US and Canada Requirements
ANSI/AAMI ES60601-1 CAN/CSA-C22.2 No. 60601-1	Medical Requirements
EN 62368-1	European Requirements.
EN 60601-1	European Requirements and Medical Requirements
CB Certificate and Report	(All CENELEC Countries)
CHINA CQC Approval	China Requirements
UKCA Mark	UK Requirements

ENVIRONMENTAL SPECIFICATIONS

EMI Emissions

The μMP series has been designed to comply with the Class B limits of EMI requirements of EN55022 (FCC Part 15) and CISPR 22 (EN55022) for emissions and relevant sections of EN61000 (IEC 61000) for immunity.

μMP04 is tested at 400W at low line and >100Vac input, and 600W at high line>200Vac input using resistive load.
 μMP09 is tested at 550W at low line and >100Vac input, and 1100W at high line>200Vac input using resistive load.
 μMP10 is tested at 1000W at low line and >100Vac input, and 1200W at high line>200Vac input using resistive load.
 μMP16 is tested at 1200W at low line and >100Vac input, and 1600W at high line>200Vac input using resistive load.

Conducted Emissions

The applicable standard for conducted emissions is EN55022 (FCC Part 15). Conducted noise can appear as both differential mode and common mode noise currents. Differential mode noise is measured between the two input lines, with the major components occurring at the supply fundamental switching frequency and its harmonics. Common mode noise, a contributor to both radiated emissions and input conducted emissions, is measured between the input lines and system ground and can be broadband in nature.

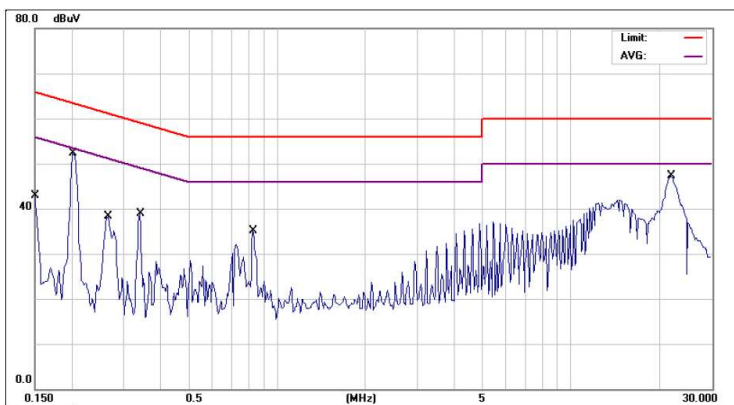

The μMP series power supplies have internal EMI filters to ensure the converters' conducted EMI levels comply with EN55022 (FCC Part 15) Class B limits. The EMI measurements are performed with resistive loads at maximum rated loading.

Sample of EN55022 Conducted EMI Measurement at 100Vac Input

Note: Blue Line refers to Advanced Energy margin, which is 6dB below the CISPR international limit. Red Line refers to the Advanced Energy Average margin, which is below the CISPR international limit.

Conducted EMI emissions specifications of the μMP series:

Parameter	Model	Symbol	Min	Typ	Max	Unit
FCC Part 15, class B	All	Margin	-	-	6	dB
CISPR 32 (EN55022), class B	All	Margin	-	-	6	dB

ENVIRONMENTAL SPECIFICATIONS

Radiated Emissions

Unlike conducted EMI, radiated EMI performance in a system environment may differ drastically from that in a stand-alone power supply. The shielding effect provided by the system enclosure may bring the EMI level from Class A to Class B. It is thus recommended that radiated EMI be evaluated in a system environment. The applicable standard is EN55022 Class B (FCC Part 15). Testing AC-DC converters as a stand-alone component to the exact requirements of EN55022 can be difficult because the standard calls for 1m lead to be attached to the input and outputs and aligned such as to maximize the disturbance. In such a set-up, it is possible to form a perfect dipole antenna that very few AC-DC converters could pass. However, the standard also states that an attempt will be made to maximize the disturbance consistent with the typical application by varying the configuration of the test sample.

Note: When using cable connections longer than 0.3 meters, between output terminals and load, use of common mode ferrites for additional filtering is recommended. Laird Technologies part numbers 28B1142-000, 28B1250-000, or 28B0625-000 (or equivalents) are to be used.

ENVIRONMENTAL SPECIFICATIONS

Operating Temperature

The μMP series power supplies will start and operate within stated specifications at an ambient temperature from -40 °C to 70 °C under all load conditions with internal fan. Derate each output 2.5% per degree from 50 °C to 70 °C. Cold start at -20 °C, allow 10 min warm-up before all outputs are within specification. Reverse air to 40 °C max due to fan derating.

Forced Air Cooling

The μMP series power supplies include internal cooling fans as part of the power supply assembly to provide forced air-cooling to maintain and control temperature of devices and ambient temperature in the power supply to appropriate levels. There are 1 fan in μMP04 case and 2 fans in μMP10/16 case. The standard direction of airflow is from the fan side through the power supply with exhaust on the output side of the power supply. Reverse airflow option is required with some derating allowed. Allow 40 °C max ambient for reverse airflow. Please see table 16 for acoustic noise of μMP series Gen II.

Fan speed is controlled by thermal sensors in case and modules. In the event of a fan fault condition, the unit will protect by latching off. AC input or Global Inhibit must be recycled to turn the unit back on after a fan fault condition.

Table 16. Acoustic Noise	
Model	Spec
μMP04/09 Series	< 35 dBA at 25 °C at 50% Case O/P
μMP10/16 Series	< 40 dBA at 25 °C at 50% Case O/P

See below sound pressure level vs case power curve for Gen I μMP1 and Gen II μMP10/16 comparison.

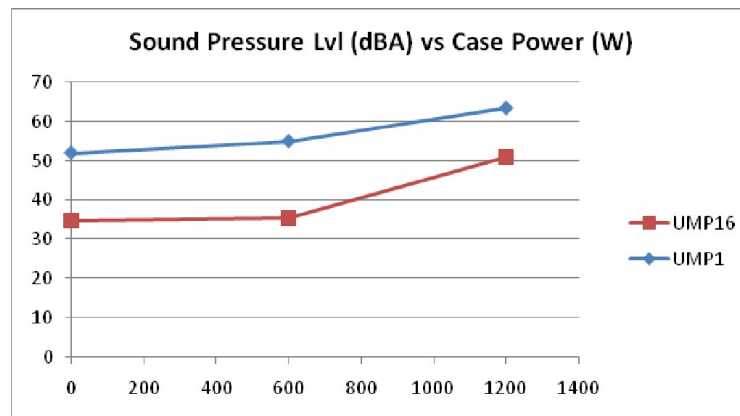

ENVIRONMENTAL SPECIFICATIONS

Power Derating Curves

μMP series can operate up to a maximum ambient temperature of 70°C with derating, below is the μMP10 derating curves.

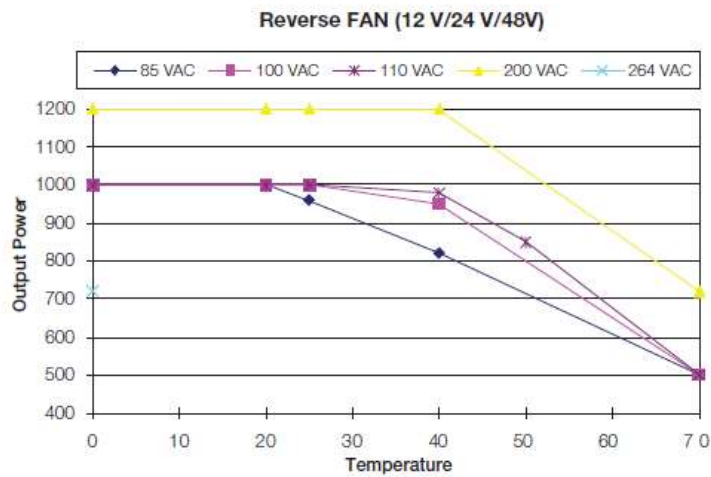
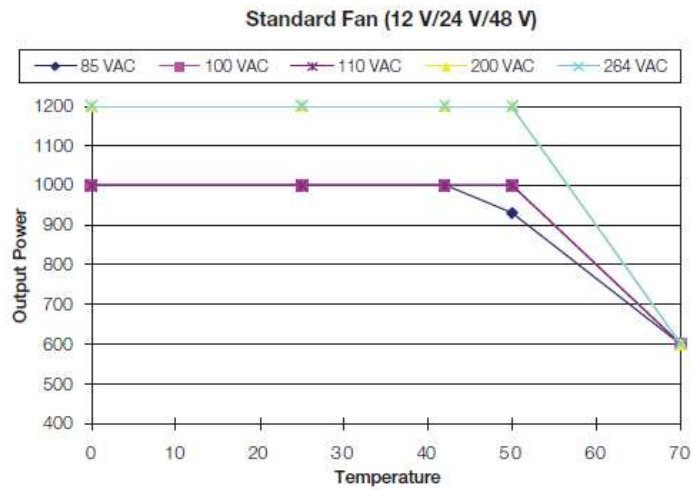

ENVIRONMENTAL SPECIFICATIONS

Storage and Shipping Temperature

The μMP series power supplies can be stored or shipped at temperatures between -40°C to +85°C and relative humidity from 10% to 95% non-condensing.

Altitude

The μMP series will operate within specifications at altitudes up to 10,000 meters above sea level. The power supply will derate linear to 50% from 10,000 to 30,000 feet above sea level.

Humidity

The μMP series will operate within specifications when subjected to a relative humidity from 10% to 95% non-condensing. The μMP series can be stored in a relative humidity from 10% to 95% non-condensing.

Vibration

The μMP series power supply will pass the following vibration specifications:

Non-Operating Random Vibration

Acceleration	6.06	gRMS	
Frequency Range	10 - 2000	Hz	
Duration	30	Mins	
Direction	3 mutually perpendicular axis		
PSD Profile	FREQ (Hz)	SLOPE (db/oct)	PSD (g ² /Hz)
	10	/	0.005
	20	/	0.01
	80 - 350	/	0.04
	2000	/	0.007

Operating Random Vibration

Acceleration	4.22	gRMS	
Frequency Range	10 - 500	Hz	
Duration	30	Mins	
Direction	3 mutually perpendicular axis		
PSD Profile	FREQ (Hz)	SLOPE (db/oct)	PSD (g ² /Hz)
	10 - 350	/	0.04
	500	/	0.0198

ENVIRONMENTAL SPECIFICATIONS

Shock

The μMP series power supply will pass the following shock specifications:

Non-Operating Trapezoidal-Wave Shock

Acceleration	30	G
Duration	26	mSec
Pulse	Trapezoidal-Wave	
Number of Shock	1 shock in each of 6 directions	

Operating Half-Sine Shock

Acceleration	40	G
Duration	6	mSec
Pulse	Half-Sine	
Number of Shock	1 shock in each of 6 directions	

POWER AND CONTROL SIGNAL DESCRIPTIONS

AC Input Connector

This connector supplies the AC Mains to the μMP series power supply.

- Pin 1 – AC Neutral
- Pin 2 – AC Line (hot)
- Pin 3 – Chassis (earth) ground

Case Control Signal Connector – J1

The μMP series contains a 10 pins control signal header providing an analogue control interface, standby power and I²C interface signal connections.

Input AC OK - "collector" / Input AC OK - "emitter" - (pins 1,2)

Input ACOK - "collector" and Input ACOK - "emitter" are output of an uncommitted bipolar junction transistor. There is an internal 4.7 ohm resistor in series with the collector of the transistor for current limiting. The transistor shall turn ON when the input mains level is Good >85Vac and it shall turn OFF when input voltage is <80Vac. Sink current: 50mA maximum, 5ms minimum warning time.

A green LED is provided in the μMP case as visual indicator of the status of ACOK signal.

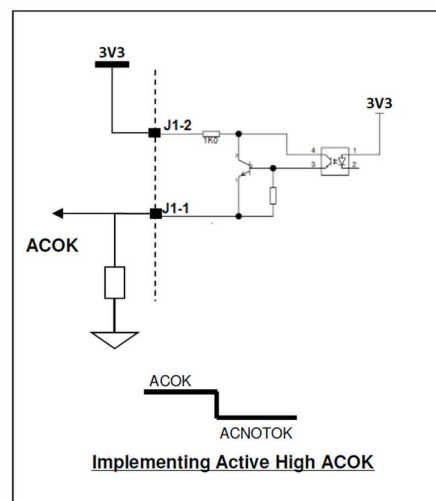
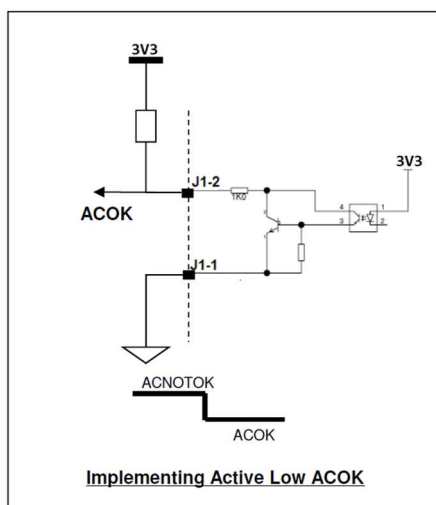
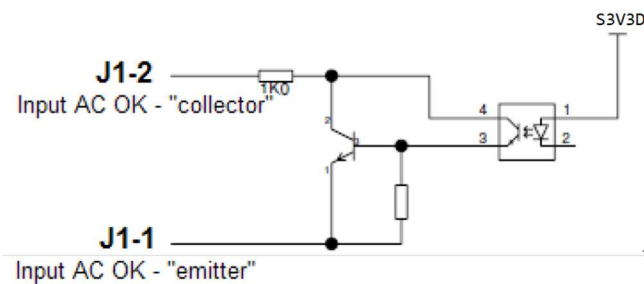

POWER AND CONTROL SIGNAL DESCRIPTIONS

Global DC OK - “collector” /Global DC OK - “emitter” - (pins 3,4)

Global DC OK - “collector” and Global DC OK - “emitter” are output signals of uncommitted bipolar junction transistor, there is an internal 4.7 ohm resistor in series with the collector of the transistor for current limiting. The transistor shall turn ON when the DC output of all modules have good regulation, otherwise it will turn OFF. A green LED is provided as a visual indicator of the DC OK status. Sink current: 50mA max.

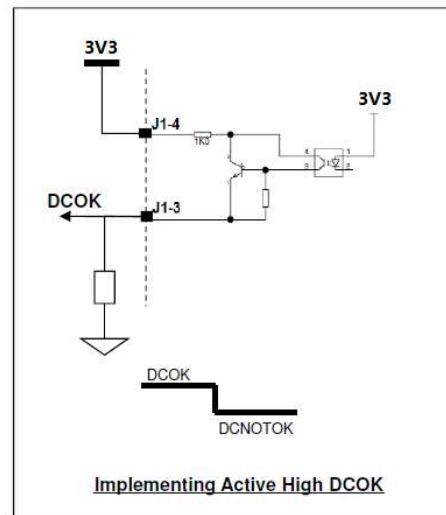
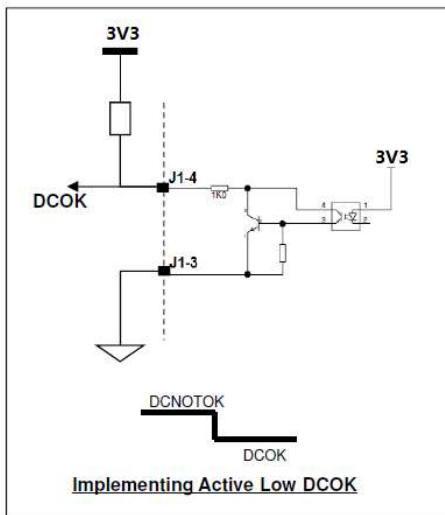
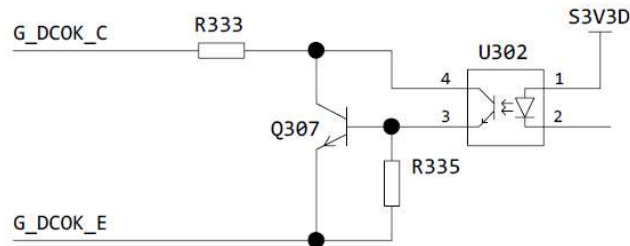

Global inhibit/optional enable logic “1” - (pin 6)

Global inhibit/optional enable logic “1” (default setting). Active low, when pin is left open or pulled Low, all the modules are ON. Pulling the pin to logic level Hi (>2.31- 3V) will turn OFF all the modules of the power supply. There is an internal 2.2K ohm resistor pulling the signal to ground to make the level low when pin is left floating. It has the flexibility to be used either 5V or 3.3V pull-up on system side as long as the voltage on the DSP pin should not exceed 3.3V (DSP supply). You can change the 1K ohm to 2.5K - 1.5K ohm to ensure that DSP pin voltage will not exceed its rating and it can meet minimum voltage to be considered as HIGH.

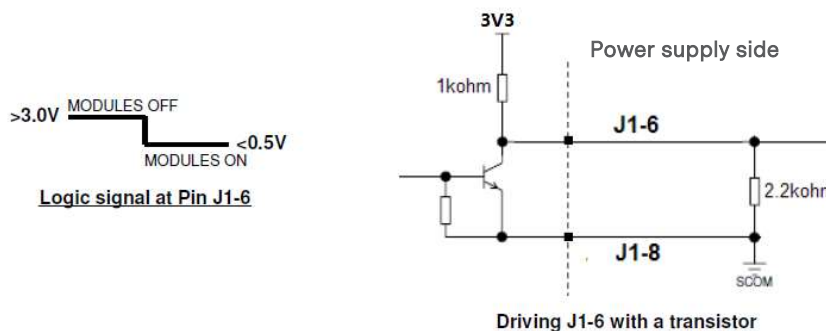

POWER AND CONTROL SIGNAL DESCRIPTIONS

Global inhibit/optional enable logic “0” - (pin 7) - For μMP 10/16

Enable logic “0” (default setting). Active high - when pin is left open or pulled high, all the PSU modules are ON. Pulling pin 7 to <math><0.5V</math> will turn OFF all the modules. There is an internal 2.2K ohm resistor pulling the signal to internal 3.3V supply to make the level high when pin is left floating.

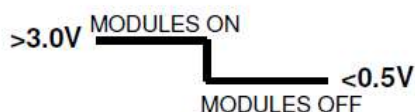

Logic signal at Pin J1-7

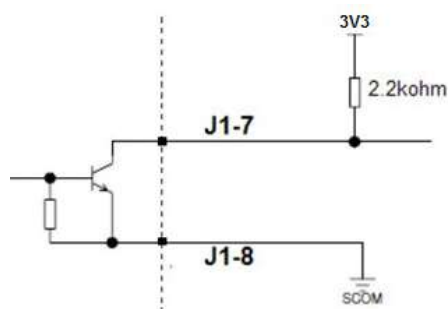

Driving J1-7 with a transistor

Global inhibit/optional enable logic “0” - (pin 7) - For μMP 04/09

Enable logic “0” (default setting). Active high - when pin is left open or pulled high, all the PSU modules are ON. Pulling pin 7 to <math><0.5V</math> will turn OFF all the modules. There is no internal pull up to 3.3V for EN0 on μMP04/09. Instead level shifter is implemented for EN0 on μMP04/09. If EN0 pin is left floating, you will measure 3.3V on the pin.

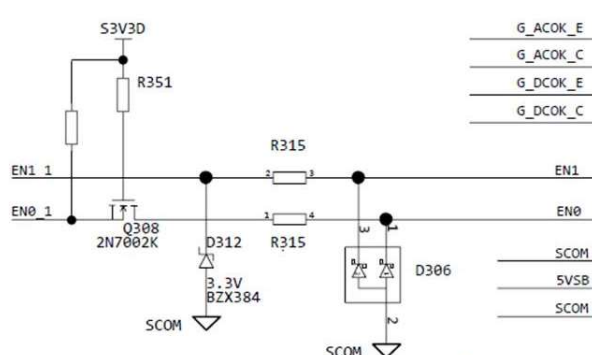
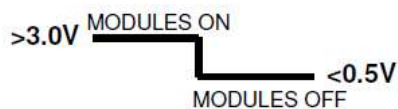

Advantage of the level shifter will allow customer to drive EN0 flexibly.

- Gate of 3.3V circuit
- Gate of 5V circuit
- Comparator/Op-amp output of 12V circuit
- OC (Open Collector as you shown in your diagram)
- Other output or gate that will not exceed the derating of the level shifter

Note: Pin 6 and pin 7 are independent signals, both signals must assume the correct logic to turn ON the modules. By default, Pin 6 is low (when pin is floating) and pin 7 is high (when pin is floating) and all modules are ON; change the logic state of either pins to turn the output modules OFF.

Note: Case option code 3 “Global Enable” reverses the modules ON/OFF status described above.

POWER AND CONTROL SIGNAL DESCRIPTIONS

Global inhibit/optional enable return - (pin 8)

This pin is ground reference for global enable/optional enable. It is electrically connected to pin 10 (+5VSB housekeeping Return).

+5VSB housekeeping - (pin 9)

This pin is the standby output of the power supply rated 5V/2A. This output is available every time the input AC voltage to the power supply is within 85Vac - 264Vac. This output is not affected by global Inhibit function.

+5VSB housekeeping return - (pin 10)

The ground reference of +5VSB housekeeping, this ground is not connected to the chassis of the power supply.

POWER AND CONTROL SIGNAL DESCRIPTIONS

Case I²C Bus Signal Connector - J2

5Vcc bus - (pin 1)

This pin is an input to the μMP case, supplying 5V to this signal will provide external power to the I²C devices - EEPROM and Microcontroller. The pin can be used to enable the I²C communication using external power supply to allow reading of manufacturing from a non-working PSU without powering the supply. Do not supply voltage >5.5V to prevent damaging the I²C devices.

Secondary return (COM) - (pin 3)

Ground reference for the signals of J2 connector. This pin is electrical connected to pin 10 (+5V VSB housekeeping return of J1 connector).

SDA, SCL (I²C Data and Clock Signals) - (pins 2,4)

Please refer to “Communication Bus Descriptions” section.

A2, A1, A0 (I²C Address BIT 2, BIT1, BIT0 Signals) - (pins 5,7,9)

Please refer to “Communication Bus Descriptions” section.

DC Output Control Signal Connector

Current Share - (pin 3)

Current share pin is an input/output signal of the module. When multiple modules are connected in parallel, the current share pins of each of the parallel modules must be connected together to achieve equal current sharing. Failure to connect the current sharing pin while the output of the modules are in parallel connection can cause one or more of the modules to sink current from the other parallel modules and fail. Since the output voltage of current share signal is proportional to the actual output current the pin can be used as output current monitor, the pin will have 6V nominal output at full rated load.

Module Inhibit Return and Module ISO Inhibit - (pins 4,5)

Isolated Inhibit input signals use to remotely enable/disable the module. Apply 3.3V or 5V across the Module ISO Inhibit and Module Inhibit Return to disable the module. This pin driving the diode side of an optocoupler to drive the internal enable signal, an internal 1K ohm is in series with the diode.

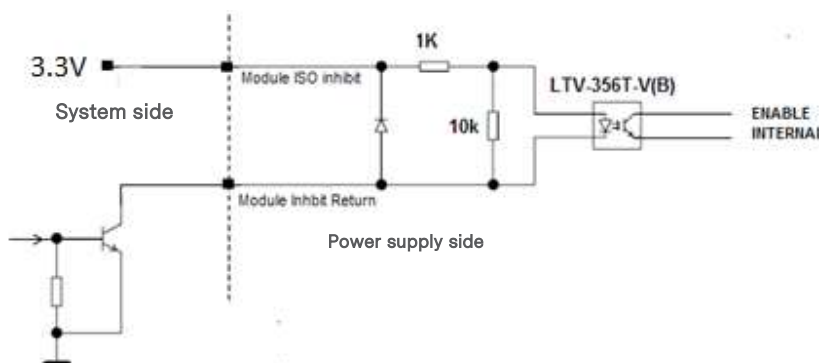

POWER AND CONTROL SIGNAL DESCRIPTIONS

SCOM - (pin 6)

SCOM is ground reference of the output module. This is connected to 'V-' output of the module.

- RMT sense/+RMT sense - (pins 7,10)

Remote sense of the output modules is used to compensate up to 500mV of cable drop. Connect the -RMT sense and +RMT sense to the output 'V-' and 'V+' respectively at the point of load to compensate up to 500mV of voltage drop along the power lines.

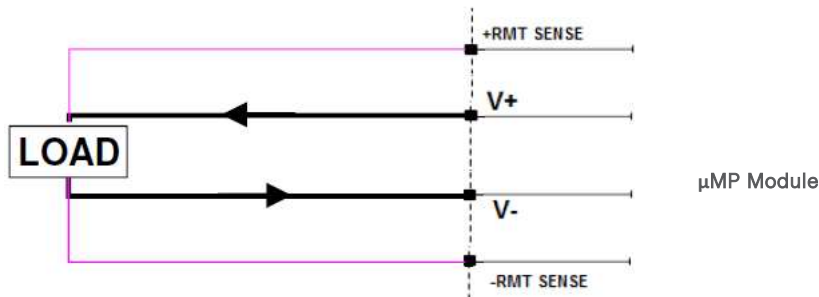

Margin and Remote margin/V prog - (pins 8,9)

Used to remotely adjust the output voltage regulation to 95% (Margin Low) or 105% (Margin High). Connect Remote margin (Pin 9) to Margin (Pin 8) to adjust voltage output level to 105% of the rated output. Connect Remote margin (Pin9) to SCOM (Pin 6) to adjust the voltage output level to 95% of the rated.

Remote margining using Single Pole Center Off switch to achieve 3 possible voltage level.

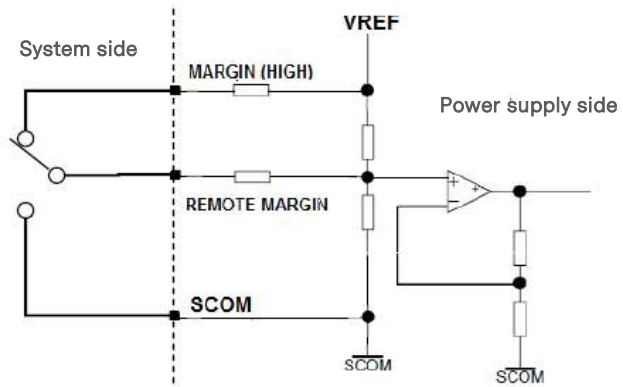

Remote margining using a potentiometer to get voltage adjustment range between 95% -105% of nominal rating.

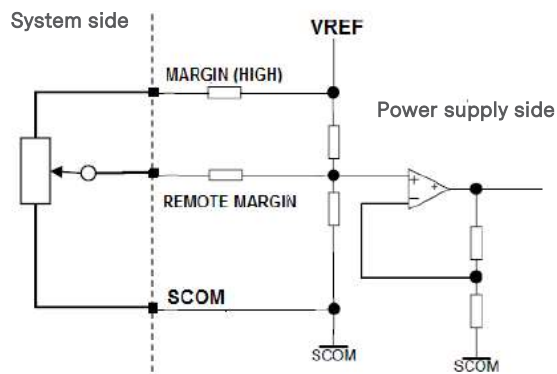

POWER AND CONTROL SIGNAL DESCRIPTIONS

Since pin9 of signal connector on the module has the dual functions, remote margin and Vprog. By default it is remote margin. Table 17 provides modification reference to obtain the Vprog function for S2 module (240W). With this modification, Vprog function allows system to linearly adjust the output voltage by varying the control voltage on the Vprog pin (pin9 of the signal connector) with regards to output return.

Table 17. Vprog modification for reference					
Vprog Voltage (V)	μMP Module	Output Voltage Range (V)	Change Option Resistors		
			R74 (Ω)	R109 (KΩ)	R148 (KΩ)
0-5	48V-G2	0 to 48	1	2	12
	24V-G2	0 to 24	1	2	12
	12V-G2	0 to 12	1	2	11
	5V-G2	0 to 5	1	2	12

With the resistors modification, the control voltage can be defined to meet system requirement. Figure 55 demonstrates an example of Vprog (0V to 5V).

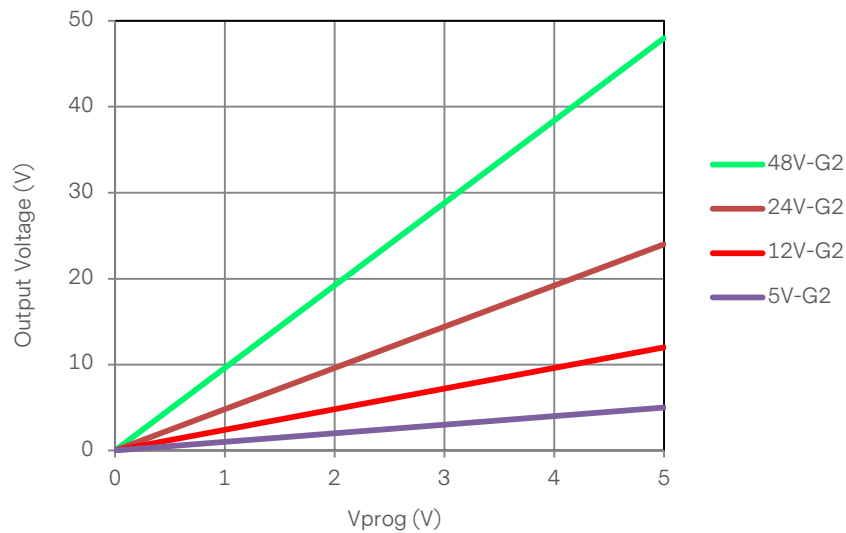

Figure 55 Example of Vprog vs. output Voltage

POWER AND CONTROL SIGNAL DESCRIPTIONS

Table 18 provides modification reference to obtain the Vprog function for SK module (1000W).

Table 18. Vprog modification for reference			
Vprog Voltage (V)	μMP Module	Output Voltage Range (V)	Change Option Resistors
0-5	48V-G2	0 to 48	Unstuff R390, R391; Stuff R311 with 3.3K ohms; Unstuff R410, R418; Stuff R406 with 1K ohms; Change R417 to 0 ohm;
	24V-G2	0 to 24	Change R261 to 100 ohms; Change R262 to 12K ohms; Change R270 to 12K ohms;

With the resistors modification, the control voltage can be defined to meet system requirement. Figure 56 demonstrates an example of Vprog (0V to 5V).

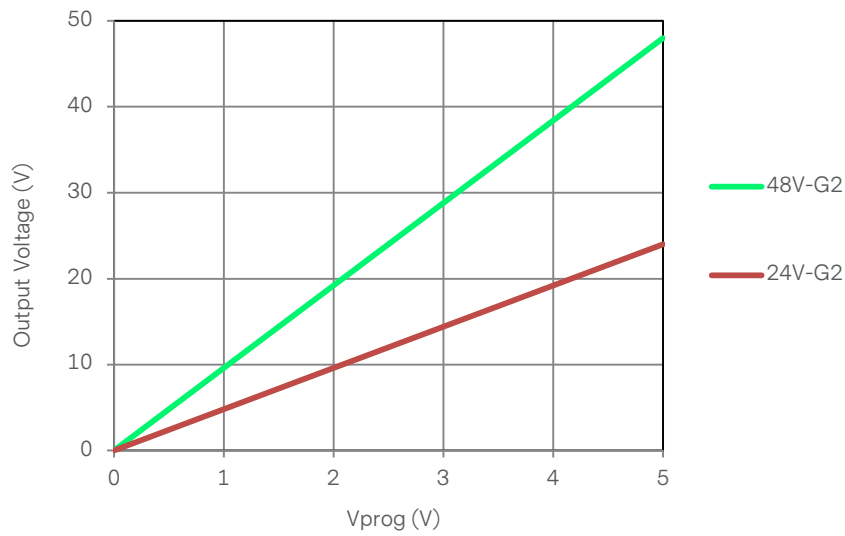

Figure 56 Example of Vprog vs. output Voltage

POWER AND CONTROL SIGNAL DESCRIPTIONS

DC Output Control Signal Connector - I## Module

-RMT sense V2 / +RMT sense V2 - (pins 1,2)

Remote sense for output V2, can compensate up to 500mV cable drop. Connect the -RMT sense V2 and +RMT sense V2 to the output 'V2 COM' and 'V2+' respectively at the point of load to compensate up to 500mV of voltage drop along the power lines.

Module Inhibit Return and Module ISO Inhibit - (pins 4,5)

The Module Inhibit enable/disable both outputs.

SCOM - (pin 6)

SCOM is ground reference of the output module, this is connected to COM of output V2.

-RMT sense V1 / +RMT sense V1 - (pins 7,10)

Remote sense for output V1, can compensate up to 500mV cable drop. Connect the -RMT sense V1 and +RMT sense V1 to the output 'V1 COM' and 'V1+' respectively at the point of load to compensate up to 500mV of voltage drop along the power lines.

COMMUNICATION BUS DESCRIPTIONS

I²C Bus Signals – J2

The μMP series power supply contains enhanced monitor and control functions implemented via the I²C bus. The μMP series I²C functionality (PMBus™ and FRU data) can be accessed via the output connector control signals. The communication bus is powered either by the internal 3.3V supply or from an external power source connected to the standby output (i.e. accessing an unpowered power supply as long as the standby output of another power supply connected in parallel is on).

If units are connected in parallel or in redundant mode, the standby outputs must be connected together in the system. Otherwise, the I²C bus will not work properly when a unit is inserted into the system without the DC source connected.

Note: PMBus™ functionality can be accessed only when the PSU is powered-up. Guaranteed communication I²C speed is 100KHz.

SDA, SCL (I²C Data and Clock Signals) - (Pins 2, 4)

These pins for I²C communication are internally pulled up to internal 3.3V supply with a 20K ohm resistor; a current source pull-up can also be used. If multiple units are used inside a system, the 5V housekeeping supply of each unit must be connected in parallel in the system, otherwise, the SCL and SDA bus will be pulled low by the unit without AC power.

A0, A1, A2 (I²C Address BIT 0, BIT1 Signals) - (pins 5,7,9)

Multiple configured μMP power supplies can be used in a single system, the power supplies can have parallel outputs or providing multiple outputs. The μMP case has three address pins allowing the system to assign different addresses to multiple PSUs used within the system. The I²C devices inside the μMP case are EEPROM to store FRU data and microcontroller for PMBus™. Pull the address pin to secondary return (COM) to set the address to “0” or High (or open) to set it the address to “1”.

I²C Bus Communication Interval

The interval between two consecutive I²C communications to the power supply should be at least 50ms to ensure proper monitoring functionality.

I²C Bus Signal Integrity

The noise on the I²C bus (SDA, SCL lines) due to the power supply will be less than 500mV peak-to-peak. This noise measurement should be made with an oscilloscope bandwidth limited to 100MHz. Measurements should be made at the power supply output connector with 2.2K ohm resistors pulled up to standby Output and 20pF ceramic capacitors to standby output return.

The noise on the address lines A0 and A1 will be less than 100mV peak-to-peak. This noise measurement should be made at the power supply output connector.

COMMUNICATION BUS DESCRIPTIONS

I²C Bus Internal Implementation, Pull-ups and Bus Capacitances

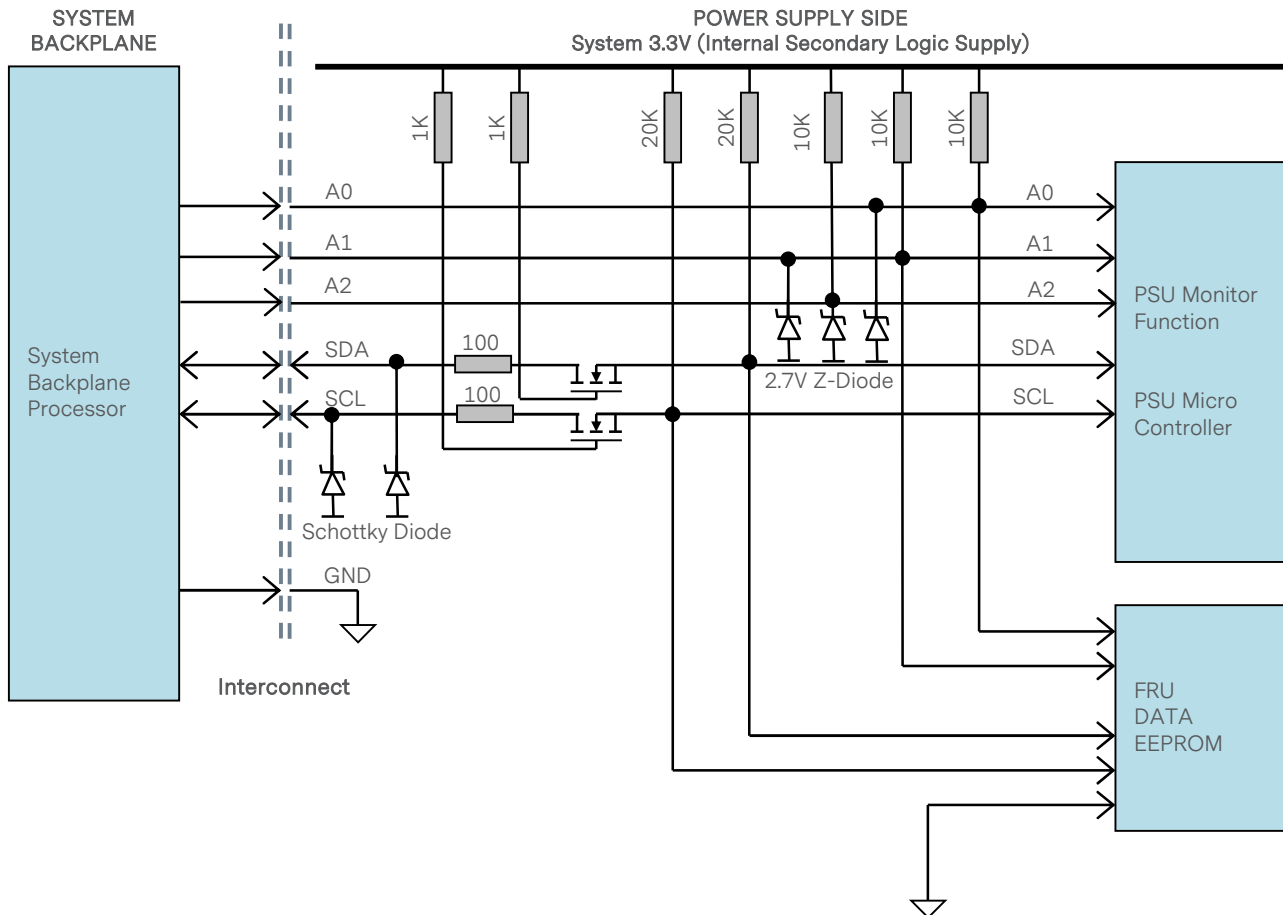

I²C Bus - Recommended external pull-ups

Electrical and interface specifications of I²C signals (referenced to standby output return pin, unless otherwise indicated):

Parameter	Condition	Symbol	Min	Type	Max	Unit
SDA, SCL Internal Pull-up Resistor		R_{int}	-	20	-	Kohm
SDA, SCL Internal Bus Capacitance		C_{int}	-	0	-	pF
Recommended External Pull-up Resistor	1 to 8 PSU	R_{ext}	-	2.2	-	Kohm

COMMUNICATION BUS DESCRIPTIONS

Logic Levels

µMP series power supply I²C communication bus will respond to logic levels as per below:

Logic High: 3.3V nominal (Spec is 2.1V to 5.5V)**

Logic Low: 500mV nominal (Spec is 800mV max)**

**Note: Advanced Energy 73-769-001 I²C adapter was used.

Timings

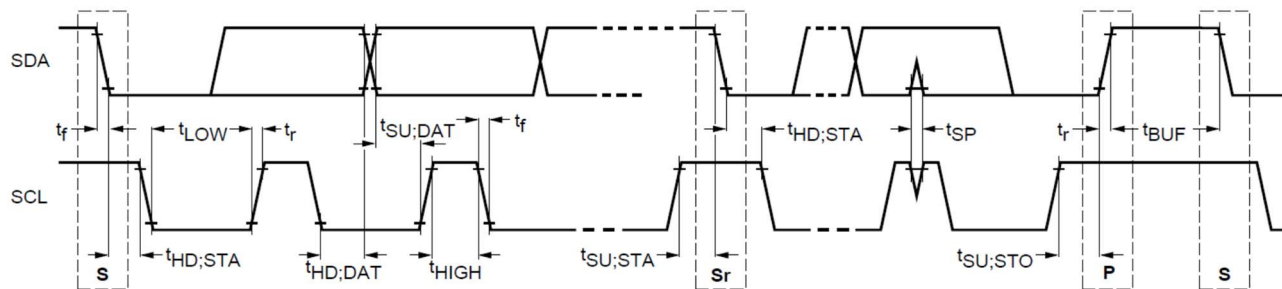

Parameter	Symbol	Standard-Mode Specs		Actual Measured		Unit
		Min	Max			
SCL clock frequency	f_{SCL}	0	100	99		KHz
Hold time (repeated) START condition	$t_{HD;STA}$	4.0	-	4.68		µS
LOW period of SCL clock	t_{LOW}	4.7	-	14.8		µS
HIGH period of SCL clock	t_{HIGH}	4.0	-	4.1		µS
Setup time for repeated START condition	$t_{SU;STA}$	4.7	-	5.7		µS
Data hold time	$t_{HD;DAT}$	0	3.65	0.5		µS
Data setup time	$t_{SU;DAT}$	250	-	521		nS
Rise time	t_r	-	1000	SCL = 896	SDA = 540	nS
Fall time	t_f	-	300	SCL = 132	SDA = 220	nS
Setup time for STOP condition	$t_{SU;STO}$	4.0	-	5.66		µS
Bus free time between a STOP and START condition	t_{BUF}	4.7	-	31.06***		µS

***Note: Advanced Energy 73-769-001 I²C adapter (USB-to-I²C) and Universal PMBus™ GUI software was used.

COMMUNICATION BUS DESCRIPTIONS

Device Addressing

The μMP series will respond to support commands on the I²C™ bus that are addressed according to pins A0, A1 and A2 pins of output connector.

Address pins are held high by default via pulled up to internal 3.3V housekeeping with a 10K ohm resistor. To set the address as “0”, the corresponding address line should be pulled down to logic ground level. Below table shows the address of the power supply with A0, A1 and A2 pins set to either “0” or “1”.

PSU Slot	Slot ID Bits			PMBus™ Address	EEPROM (FRU) Read Address
	A0	A1	A2		
1	0	0	0	0x30	0xA0
2	0	0	1	0x32	0xA2
3	0	1	0	0x34	0xA4
4	0	1	1	0x36	0xA6
5	1	0	0	0x38	0xA8
6	1	0	1	0x3A	0xAA
7	1	1	0	0x3C	0xAC
8	1	1	1	0x3E*	0xAE

* Default PMBus™ address when A0, A1, A2 are left open.

COMMUNICATION BUS DESCRIPTIONS

I²C Clock Synchronization

The μMP series power supply applies clock stretching. An addressed slave power supply holds the clock line (SCL) low after receiving (or sending) a byte, indicating that it is not yet ready to process more data. The system master that is communicating with the power supply will attempt to raise the clock to transfer the next bit but must verify that the clock line was actually raised. If the power supply is clock stretching, the clock line will still be low (because the connections are open-drain).

The maximum clock low timeout for μMP is 25 millisecond.

The maximum transaction timeout condition for clock stretching for μMP is 100 millisecond.

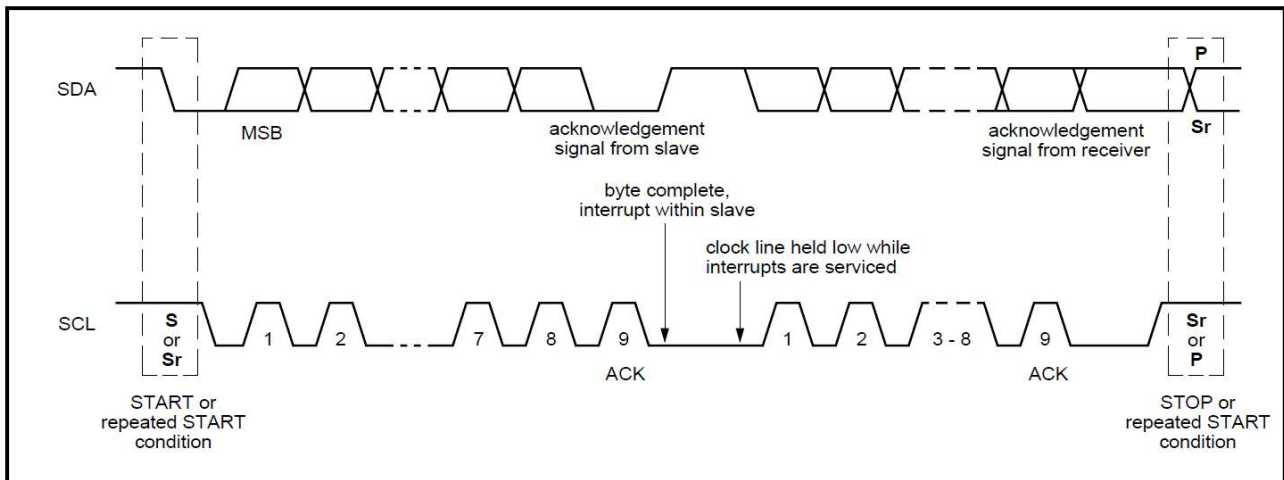

PMBus™ SPECIFICATIONS

The μMP series is compliant with the industry standard PMBus™ protocol for monitoring and control of the power supply via the I²C interface port.

μMP Series PMBus™ General Instructions

Equipment Setup

The following is typical I²C communication setup:

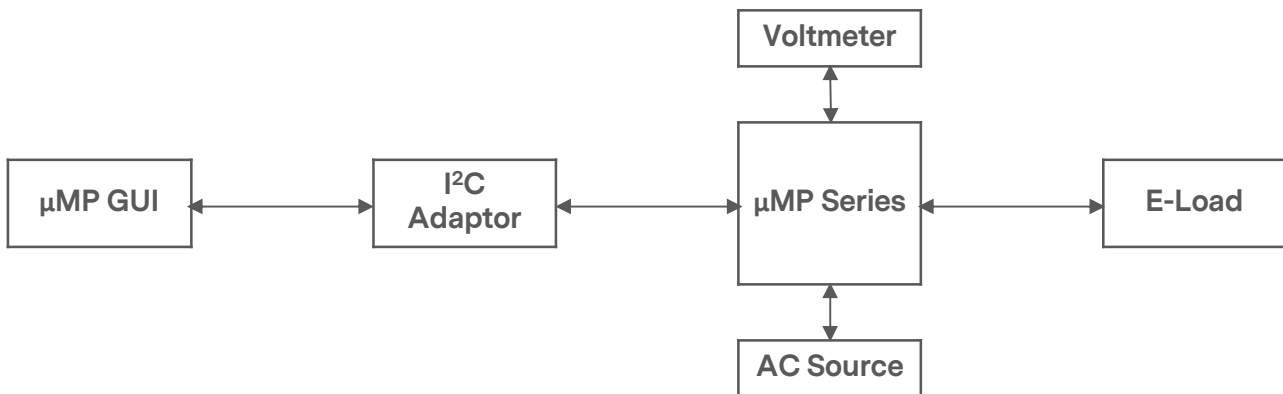

PMBus™ Writing Instructions

When writing to any PMBus™ R/W registers, ALWAYS do the following:

Disable Write Protect (command 10h) by writing any of the following accordingly:

- Levels: 00h – Enable writing to all writeable commands
- 20h – Disables write except 10h, 01h, 00h, 02h and 21h commands
- 40h – Disables write except 10h, 01h, and 00h commands
- 80h – Disable write except 0x00h

To save changes on the USER PMBus™ Table:

Use send byte command: 15h STORE_USER_ALL

Wait for 5 seconds, turn-off the PSU, wait for another 5 seconds before turning it on.

PMBus™ SPECIFICATIONS

The µMP Series Supported PMBus™ Command List:

Command Code	Command Name	Default Value	Access Type	Data Bytes	Data Format	Description
00h	PAGE	00	R	1	Hex	
01h	OPERATION	80	R/W	1	Bitmapped	Used to turn the unit ON/OFF 80h - Enable the unit 40h - Disable the unit
	b7:6	10b				
	b5:4	00b				Reserved
	b3:2	00b				Reserved
	b1:0	00b				Reserved
02h	ON_OFF_CONFIG	1E	R	1		
03h	CLEAR_FAULTS		S			
10h	WRITE_PROTECT	80	R/W	1		Used to Control Writing to the PMBus Device 80h - Disables write except 10h 40h - Disables write except 10h, 01h, 00h 20h - Disables write except 10h, 01h, 00h, 02h 00h - Enables write to all writeable commands.
15h	STORE_USER_ALL	-	S	0		Copies the operating memory table to the matching USER non-volatile memory.
19h	CAPABILITY	80	R	1		
35h	VIN_ON	-	R	2		Default: 82Vac
36h	VIN_OFF	-	R	2		Default: 75Vac
3Ah	FAN_CONFIG_1_2	D5	R	1		Used to configure up to 2 fans associated with one PMBus device.
3Bh	FAN_COMMAND_1	0	R/W	2	Direct	Default Value is 0 (Fan can be adjust itself by load and temperature) Valid Range: 0 - 32767RPM
50h	OT_FAULT_RESPONSE	78	R	1		Turn PSU OFF and will retry indefinitely.
58h	VIN_UV_WARN_LIMIT	EA90	R	2	Linear	(82Vac)
59h	VIN_UV_FAULT_LIMIT	EA58	R	2	Linear	(75Vac)
5Ah	VIN_UV_FAULT_RESPONSE	F8	R	1		

PMBus™ SPECIFICATIONS

The µMP Series Supported PMBus™ Command List:

Command Code	Command Name	Default Value	Access Type	Data Bytes	Data Format	Description
78h	STATUS_BYTE	00	R	1	Bitmapped	Returns the summary of critical faults.
	b7 - BUSY					A fault was declared because the device was busy and unable to respond.
	b6 - OFF					Unit is OFF.
	b5 - VOUT_OV					Output over-voltage fault has occurred.
	b4 - IOUT_OC					Output over-current fault has occurred.
	b3 - VIN_UV					An input under-voltage fault has occurred.
	b2 - TEMPERATURE					A temperature fault or warning has occurred.
	b1 - CML					A communication, memory or logic fault has occurred.
	b0 - NONE OF THE ABOVE					A Fault Warning not listed in bits[7:1] has occurred.
79h	STATUS_WORD	0000	R	2	Bitmapped	Summary of units Fault and warning status.
	b15 - VOUT					An output voltage fault or warning has occurred.
	b14 - IOUT/POUT					An Output current or power fault or warning has occurred.
	b13 - INPUT					An input voltage, current or power fault or warning as occurred.
	b12 - MFR					A manufacturer specific fault or warning has occurred.
	b11 - Global DC OK					The Global DC OK signal is de-asserted.
	b10 - FANS					A fan or airflow fault or warning has occurred.
	b9 - OTHER					A bit in STATUS_OTHER is set.
	b8 - UNKNOWN					A fault type not given in bits [15:1] of the STATUS_WORD has been detected.
	b7 - BUSY					A fault was declared because the device was busy and unable to respond.
	b6 - OFF					Unit is OFF.
	b5 - VOUT_OV					Output over-voltage fault has occurred.
	b4 - IOUT_OC					Output over-current fault has occurred.
	b3 - VIN_UV					An input under-voltage fault has occurred.
	b2 - TEMPERATURE					A temperature fault or warning has occurred.
	b1 - CML					A communication, memory or logic fault has occurred.
b0 - NONE OF THE ABOVE					A fault or warning not listed in bits[7:1] of this byte has occurred.	

PMBus™ SPECIFICATIONS

The µMP Series Supported PMBus™ Command List:

Command Code	Command Name	Default Value	Access Type	Data Bytes	Data Format	Description
7Ch	STATUS_INPUT	00	R	1	Bitmapped	Input related faults and warnings
	b7					VIN Overvoltage Fault
	b6					VIN Overvoltage Warning
	b5					VIN Undervoltage Warning
	b4					VIN Undervoltage Fault
	b3					Unit is OFF for insufficient Input Voltage
	b2					IIN Overcurrent Fault
	b1					IIN Overcurrent Warning
	b0					PIN overpower Warning
7Dh	STATUS_TEMPERATURE	00	R	1	Bitmapped	Temperature related faults and warnings
	b7					Overtemperature Fault
	b6					Overtemperature Warning
	b5					Undertemperature Warning
	b4					Undertemperature Fault
	b3:0					reserved
7Eh	STATUS_CML	00	R	1		Communications, Logic and Memory
	b7					Invalid or unsupported Command Received
	b6					
	b5					Packet Error Check Failed
	b4					Memory Fault Detect, CRC Error
	b3					
	b2					
	b1					
	b0					
80h	STATUS_MFR_SPECIFIC	00	R	1	Bitmapped	Manufacturer Status codes
	b7					Bulk OK, 1- Bulk is within range and is ready for use
	b6					Not Used
	b5					Not Used
	b4					Not Used
	b3					Not Used
	b2					Not Used
	b1					Standby Fault, 1 If there's a standby fault.
b0					PS_ON Pin Status 1 - asserted, 0 - deasserted	

PMBus™ SPECIFICATIONS

The μMP Series Supported PMBus™ Command List:

Command Code	Command Name	Default Value	Access Type	Data Bytes	Data Format	Description
81h	STATUS_FANS_1_2	00	R	1		
	b7					Fan 1 Fault
	b6					Fan 2 Fault
	b5					Fan 1 Warning
	b4					Fan 2 Warning
	b3					Fan_1 Speed Overridden
	b2					Fan_2 Speed Overridden
	b1					
88h	READ_VIN	-	R	2	Linear	Returns input Voltage in Volts ac.
89h	READ_IIN	-	R	2	Linear	Returns input Current in Amperes
8Dh	READ_TEMPERATURE_1	-	R	2	Linear	Primary Hotspot
8Eh	READ_TEMPERATURE_2	-	R	2	Linear	Standby Hotspot
8Fh	READ_TEMPERATURE_3	-	R	2	Linear	Secondary Ambient
90h	READ_FAN_SPEED_1	-	R	2	Linear	Speed of Fan 1
91h	READ_FAN_SPEED_2	-	R	2	Linear	Speed of Fan 2
97h	READ_PIN	-	R	2	Linear	Returns the input power, in Watts.
98h	PMBUS_REVISION	22	B	1		Reads the PMBus revision number
99h	MFR_ID	“ARTESYN”	BR, ASCII	Varies		Abbrev or symbol of manufacturers name.
9Ah	MFR_MODEL	“μMP”	BR, ASCII	Varies		Manufacturers Model number, ASCII format
9Bh	MFR_REVISION	“AA”	BR, ASCII	Varies		Manufacturers, revision number, ASCII format
9Ch	MFR_LOCATION	“Philippines”	BR, ASCII	Varies		Manufacturers facility, ASCII format
9Dh	MFR_Data	“xxxxxx”	BR	Varies		Manufacture Date, ASCII format structure : YYMMDD
9Eh	MFR_Serial	“xxxxxxxxxxxxx”	BR	Varies		Default: "K975YYWWSSSSSSAAP" for 73-954-0001C-G2 , "K974YYWWSSSSSSAAP" for 73-954-0001T-G2
A0h	MFR_VIN_MIN	EAA8	R	2	Linear	Minimum Input Voltage (85Vac)
A1h	MFR_VIN_MAX	FA10	R	2	Linear	Maximum Input Voltage (264Vac)
A2h	MFR_IIN_MAX	D340	R	2	Linear	Maximum Input Current μMP16: 13A μMP04: 8A
A7h	MFR_POUT_MAX	B20	R	2	Linear	Maximum Output Power μMP16:1200W μMP04:600W
A8h	MFR_TAMBIENT_MAX	F38D	R	2	Direct	Maximum Operating Ambient Temperature (Secondary Ambient) (70degC)
A9h	MFR_TAMBIENT_MIN	E580	R	2	Direct	Minimum Operating Ambient Temperature (Secondary Ambient) (-40degC)
D6h	MODULE_EN_DELAY	0	BR	Varies	Linear	Default: 0 for all Modules
E0h	FW_PRI_VERSION	-	BR	8	ASCII	N/A
E1h	FW_SEC_VERSION	-	BR	8	ASCII	N/A

PMBus™ SPECIFICATIONS

The μMP Series Supported PMBus™ Command List:

Command Code	Command Name	Default Value	Access Type	Data Bytes	Data Format	Description
E2h	CONFIG_UNLOCK_CODE	-	BR	4	ASCII	Basic
E5h	OPTN_TIME_TOTAL	-	BR	4	ASCII	N/A
E6h	OPTN_TIME	-	BR	4	ASCII	N/A
F1h	ISP_UNLOCK_CODE	-	BR/W	4	ASCII	00h,00h,00h,00h
F2h	ISP_CTRL_CMD	-	W	1	B	N/A
F3h	ISP_STATUS_BYTE	-	R	1	B	Varies
F4h	ISP_FLASH_ADDR	-	B	4	Raw Hex	Varies
F5h	ISP_FLASH_DATA	-	BR/W	4	Raw Hex	Varies
FBh	FAN_COMMAND_1_DUTY	-	Linear	2	Basic	Default: 0% Valid Range 0-100% Disables fan control

APPLICATION NOTES

Output Ripple and Noise Measurement

The setup outlined in the diagram below has been used for output voltage ripple and noise measurements on the μMP series power supply. When measuring output ripple and noise, a scope jack in parallel with a 0.1μF ceramic chip capacitor, and a 10μF tantalum capacitor will be used. Oscilloscope can be set to 20MHz bandwidth for this measurement.

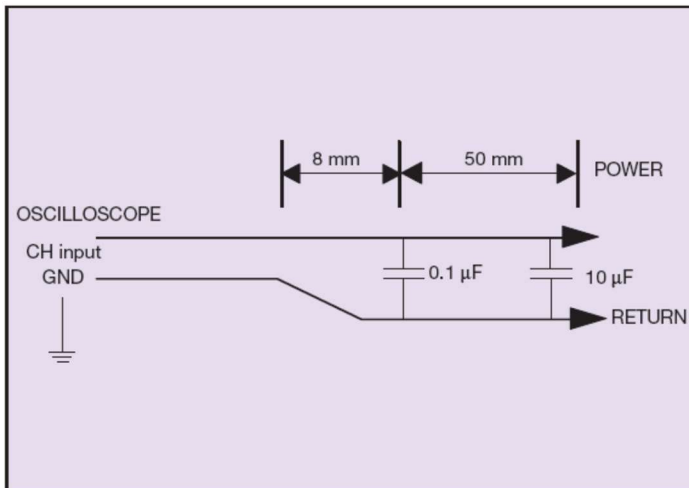

RECORD OF REVISION AND CHANGES

Issue	Date	Description	Originators
1.0	07.04.2015	First Issue	K. Wang
1.1	08.28.2015	EN0 internal pull-up resistor and Vintoe's comment	K. Wang
1.2	09.02.2015	Global inhibit description update, Richard Frost's comment	K. Wang
1.3	11.17.2015	Update 3.3V OVP mode	K. Wang
1.4	04.28.2016	Add μMP04/10 performance curve	X. Sun
1.5	07.01.2016	Update Type error	X. Sun
1.6	03.01.2017	Update the 5V housekeeping current from 1A to 2A. Update PFC frequency	K. Wang
1.7	05.05.2017	Add μMP09 model, update max lin to 8A for μMP04. Update SCL, SDA pin description	X. Sun
1.8	01.24.2018	Update the weight for SK module	K. Wang
1.9	05.09.2018	Update the pull-up resistor for ACOK, DCOK	K. Wang
2.0	10.29.2018	1. Update the altitude from 30000 feet to 10000 feet 2. Update PMBus error	K. Wang
2.1	06.24.2019	1. Update the EMI part 2. Update "Global inhibit/optional enable logic "1"(default setting)" description.	K. Wang
2.2	11.20.2019	1. Add the capacitor spec for V _O Dynamic Response 2. Efficiency 3. Fan Command description	K. Wang
2.3	03.26.2020	1. Add the series bus bar 2. Add production isolation spec	K. Wang
2.4	07.06.2020	Update safety cert from 60950-1 to 62368-1	K. Wang
2.5	07.23.2020	Update leakage current test condition from 264Vac to 240Vac	K. Wang
2.6	02.18.2021	Update error and add the trim range	K. Wang
2.7	03.02.2021	Update isolation voltage and μMP09 power to 1000W per Design's suggestion.	K. Wang
2.8	06.10.2021	1. Update ACOK waveform for μMP10 and μMP16 2. Update the μMP10/μMP16 case performance curve 3. Update the control signal pull up voltage to 3.3V 4. Cancel ACOK timing	K. Jiao/L. Li
2.9	07.08.2021	Update the 1000W 24V/12V picture and drawing	K. Wang
3.0	09.22.2021	Update the vibration spec error	K. Wang
3.1	02.10.2022	1. Update surge to 1KV per EMC report 2. Update R74 to 1ohm 3. Remove DC input for μMP10/16 since CB report	K. Wang
3.2	03.02.2022	1. Add UKCA Mark 2. Update factory setting condition to half load	K. Wang
3.3	07.07.2022	1. Update SK Module Vprog Function Guidance 2. Update shock and vibration typo	K. Jiao

RECORD OF REVISION AND CHANGES

Issue	Date	Description	Originators
3.4	12.02.2022	1. Add PMBus Logo 2. Add Acoustic Noise Spec	K. Jiao
3.5	02.03.2023	Update all the weight information	K. Jiao



For international contact information,
visit advancedenergy.com.

powersales@aei.com (Sales Support)
productsupport.ep@aei.com (Technical Support)
+1 888 412 7832

ABOUT ADVANCED ENERGY

Advanced Energy (AE) has devoted more than three decades to perfecting power for its global customers. AE designs and manufactures highly engineered, precision power conversion, measurement and control solutions for mission-critical applications and processes.

Our products enable customer innovation in complex applications for a wide range of industries including semiconductor equipment, industrial, manufacturing, telecommunications, data center computing, and medical. With deep applications know-how and responsive service and support across the globe, we build collaborative partnerships to meet rapid technological developments, propel growth for our customers, and innovate the future of power.

PRECISION | POWER | PERFORMANCE | TRUST

Specifications are subject to change without notice. Not responsible for errors or omissions. ©2022 Advanced Energy Industries, Inc. All rights reserved. Advanced Energy®, and AE® are U.S. trademarks of Advanced Energy Industries, Inc.

μMP Series Rev. 02.03.23_#3.5